

Built With

# INTEGRITY



**Start to Finish** - Flexible Manufacturing gives us complete control over the integrity of our products. From extruding the aluminum to assembling the final product; It all happens under one roof...Ours.

We make the best equipment you can buy. We Guarantee It.

**Aluminum Foodservice Catalog**

Effective January 1, 2024

# We Have Your Buts Covered.

Flexible Manufacturing by New Age Industrial.

It works great, **but** I wish it had...

**But** I wish it were a different size...

**But** I need it to...



**NEW AGE**  
INDUSTRIAL  
**NEW AGE**

800-255-0104  
NewAgeIndustrial.com

Scan To  
Learn More



## Custom Products

account for **Over 30%** of our Yearly Sales

**Because** we have made it **Easy.**

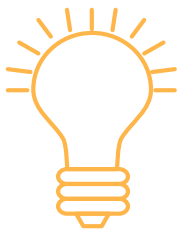

### Have An Idea

Come up with a foodservice equipment need that hasn't been filled, that YOU have the solution for.



### Write It Down

Describe your new foodservice equipment idea and explain why it is needed.

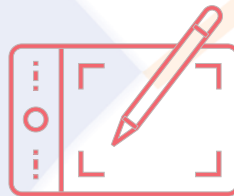

### Sketch It Out

Make a simple sketch or line drawing of what the foodservice equipment will look like.



### Submit It

Visit our website and submit the form. Be sure to upload your drawing!

NewAgeIndustrial.com

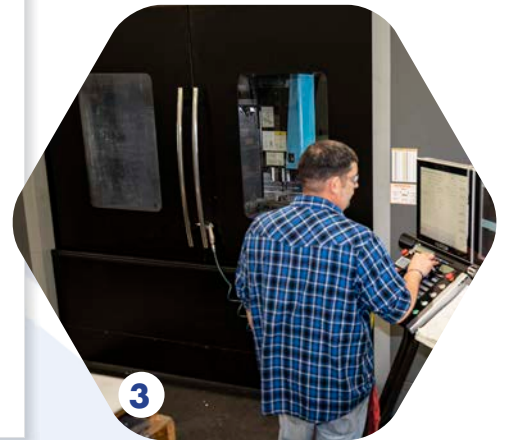
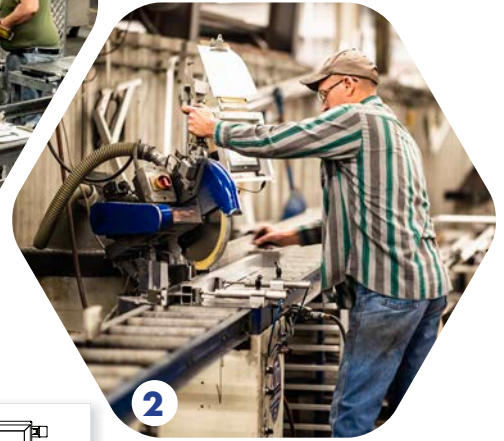
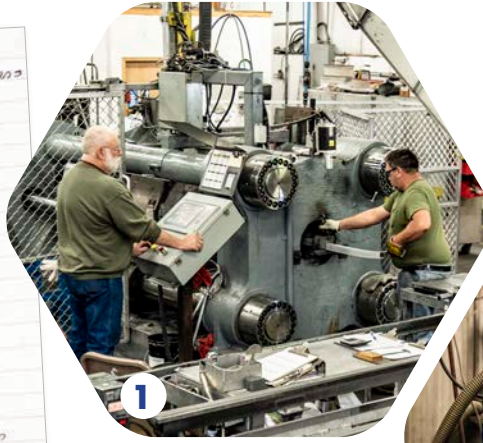
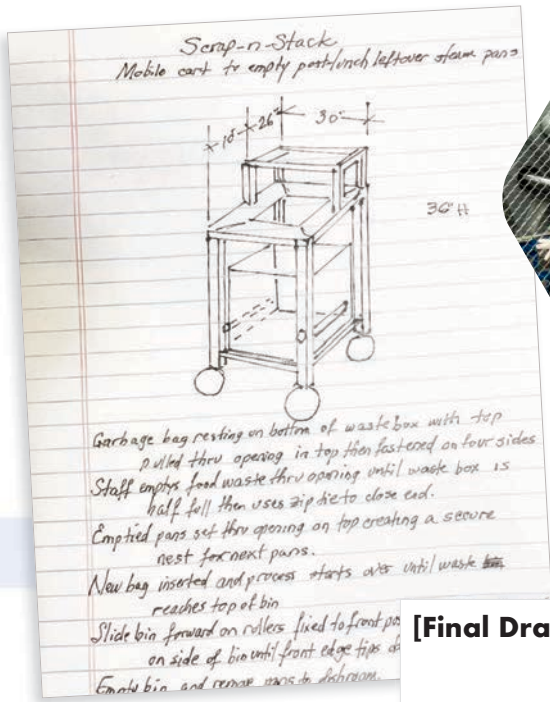

**[Final Drawing]**

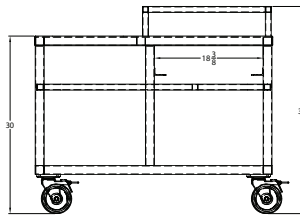
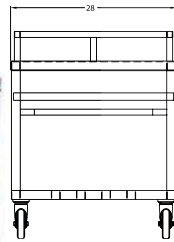
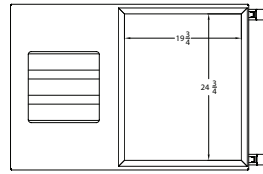

1. Tubing and angles are extruded from Primary Grade Aluminum using our extrusion press.
2. Extrusions are cut to length.
3. Parts are drilled, punched, bent and deburred before they head off to be welded.
4. Pieces are checked and measured carefully before being welded together.
5. Products are showered before final assembly and boxed for shipment.

Watch a video of the complete process.

# Table of Contents

## CORRECTIONAL

*Most New Age products can be modified for Correctional use.  
Please contact the factory for information.*

### Cabinets

Enclosed Transport Cabinets	14
Heavy Duty Cabinets	13
Security Cages	50
Utility Cabinets	50

### Carts

Mat Carts	68
Utility Carts	24

### Racks

Bun Pan Racks	10
Can Racks	33
Covers	2,71
Dunnage Racks	35-36
Insert Racks	9
Mobile Dunnage Racks	35
Stepped-Angle Pan Racks	11-12
Tray Drying Racks	23
Wide-Angle Pan Racks	11-12

### Shelving

All Welded Heavy Duty	37
All Welded T-Bar	38

### Stands

Equipment Stands	53-54
------------------	-------

### Trucks

Platform Trucks	66
-----------------	----

## FOODSERVICE

Accessories	71
-------------	----

### Baseboard

Cove Baseboard	53
----------------	----

### Cabinets

Angle-Ledge Transport Cabinets	15
Clear Door Enclosed Cabinets	13-16
Delivery Cabinets	13-16
Economy "RAC line" Cabinets	14
Enclosed Transport Cabinets	13-16
Heavy Duty Cabinets	13-16
Room Service Cabinets	17
Steamtable Pan Cabinets	14
Universal Adjustable Angle Cabinets	15
Universal Enclosed Cabinets	15
Utility Cabinets	13-16

### Carts

2-tier Carts	24,55-57
Airline Catering Carts	20
Banquet Carts	25
Bulk Carts - Frames & Tubs	60

Bussing Carts	32
Carrier Carts	20
Delivery Carts	65-67
Economy "Rac Line" Carts	56-57, 62
Enclosed Carts	13-17
Folding "L" Carts	65
Linen Carts	25
Lug Carts	59-61
Mat Carts	68
Mobile Fry Carts	19
Platter Carts	62-64
Produce Carts	55-58
Queen Marys	25
Room Service Carts	17
School Share Cart	26
Serving Carts	24, 32
Tray Delivery Carts	17-18,25
Tubular Deck Carts	56,65-66
U-Boats	65-67
Universal Carts	24,62
Utility Carts	24,32,55, 65-66

Casters	69-70
---------	-------

### Dollies

Angle Dollies	27,29-31
Bowl Dollies	29
Bread Pan Dollies	30
Bun Pan Dollies	30
Chicken Dolly	31
Chill Pac Dollies	27
Chilltray Dollies	27
Crisping Basket Dolly	27
Cup and Glass Dollies	28
Dish Rack Dollies	28
Dough Dollies	32
Food Box Dollies	27
Keg Dolly	48
Lug Dollies	32,59-61
Milk Crate Dollies	31
Mixer Bowl Dolly	29
Mixing Bowl Dolly	29
Oval Tray Dolly	30
Pizza Dough Box Dolly	32
Sheet Pan Dollies	30
Steamtable Pan Dollies	30
Super Dollies	31
Universal Dollies	31
Universal Lug Dollies	61

### Miscellaneous

Crisping Baskets	27,58
Drag Hook	30-31
Lugs	61
Tubs	61

Product Options	2,71
-----------------	------

### Racks

#### 12"x20"Pan Racks

End Loading - Standard Angle	6
End Loading - Double Deep	4

Half Size - Standard Angle	6
Lifetime Stepped Angle - Roll-In	12
Lifetime Stepped Angle	11
Lifetime Wide Angle - Roll-In	12
Lifetime Wide Angle	11
Refrigerator/Proofer - Wide Angle	3
Side Loading - Standard Angle	6
Steamtable Pan	6
Universal Wide Angle	8,11
Universal Room Service Cart	17
Universal Stepped - Adjustable	9,15
Universal Stepped - Adjustable, Roll-In	9
Universal Stepped - Roll-In	8
Universal Stepped	8
Univ. Stepped Angle Cabinet - Adjustable	15
Wide Angle	8

#### 13"x18" & 14"x18" Pan Racks

Angle Ledge Transport Cabinet	15
Lifetime Stepped Angle - Roll-In	12
Lifetime Stepped Angle	11
Lifetime Wide Angle - Roll-In	12
Lifetime Wide Angle	11
Transport/Retrieval	6
Universal Stepped - Adjustable	9
Universal Stepped - Adjustable, Roll-In	9
Universal Stepped - Roll-in	8
Universal Stepped	8
Univ. Angle Cabinet - Adjustable	15
Wide Angle	8

#### 15"x20" Tray Racks

End Loading - Standard Angle	4
Lifetime Stepped Angle - Roll-In	12
Lifetime Stepped Angle	11
Room Service Cart	17
Side Loading - Double Deep	4
Side Loading - Standard Angle	4
Tray Retrieval	6
Universal Stepped - Adjustable	9,15
Universal Stepped - Adjustable, Roll-In	9
Universal Stepped - Roll-In	8
Universal Stepped	8
Univ. Angle Cabinet - Adjustable	15

#### Bun Pan Racks

Bakery	1-3,5,7-12,20
Covers	2,71
Economy - All Welded	2,62
Economy - Knocked Down	2
Economy - Refrigerator/Proofer	3
Enclosed Racks	13-16
Full Size - End Loading	1,2,4,5,7-12,64
Full Size - End loading, Knocked Down	1,2
Full Size - Side Loading	1
Full Size - Side Loading, Knocked Down	1
Half Size	1
Insert	9
Lifetime Series	10-13
Nesting "U" Type	7
Nesting "Z" Type	7
Oven	20
Proofer	3,8,9,12



# Table of Contents

Refrigerator/Proofer .....	3,8,9,11-12
Retarder .....	3,8,9,11-12
Roll-in .....	3,8,9,12
Sheet Pan .....	1-5, 7-12
Transport/Retrieval .....	6
Universal Stepped - Adjustable .....	9
Universal Stepped - Standard .....	8
Wide Angle .....	3,4,8

## Can Racks

Economy Can Racks .....	34
First-In, First-Out Can Racks .....	34
Half Size Can Racks .....	33
Heavy Duty Can Racks .....	33-34
Mobile Can Racks .....	33-34

## Dunnage Racks

Covers .....	35
Economy RAC Line Dunnage Racks .....	35
Heavy Duty Dunnage Racks .....	36
Lifetime Series Dunnage Racks .....	36
Mobile Dunnage Racks .....	35

## Merchandiser Racks

Display Racks .....	16,18,22
Folding Merchandiser .....	22
Mobile Merchandiser .....	22
Slant Display Rack .....	16,18

## Platter Racks

Double .....	63
Economy .....	63
Heavy Duty .....	64
Standard .....	63
Universal - Economy .....	62
Universal - Standard .....	62

## Special Purpose Racks

Airline Catering Racks .....	20
Combo Racks .....	5
Display Racks .....	16,18,22
Donut Screen Racks .....	18
Food Box Racks .....	5,62
Glass Racks .....	28
Keg Racks .....	47
Oval Tray Racks .....	4
Pizza Pan Racks .....	22
Poly Box Racks .....	5,62
Pot & Pan Racks .....	19
Retrieval Racks .....	6
Slant Display Racks .....	16,18
Transport Racks .....	6
Trapezoid Tray Racks .....	6
Tray Delivery Racks .....	6,13-17
Tray Drying Racks .....	23
Universal Oval Tray .....	4,8
Universal Pizza Pan .....	22
Utility Racks .....	1-17
Wall Mount Pan Racks .....	22

<b>Security Cage</b> .....	<b>50</b>
----------------------------	-----------

<b>Security Fence</b> .....	<b>49</b>
-----------------------------	-----------

## Shelving

### Adjustable Shelving

Accessories .....	43
Adjust-A-Shelf .....	39-41
Dunnage Style Shelves .....	39,42
Economy RAC Line Shelves .....	42
HD Shelves .....	39,42
Keg Shelving .....	47
Louvered Shelves .....	40,42,47
Mobile Shelving .....	37-42
Posts .....	43
Pot & Pan Shelving .....	32
SB Shelves .....	41
Slatted Shelves .....	40,42,47
Solid Brute Shelves .....	41
Solid Reinforced Shelves .....	41
Solid Shelves .....	41,42
T-Bar shelves .....	40,42,47

### All Welded Shelving

All Welded Heavy Duty Shelving .....	37
All Welded T-Bar Shelving .....	38
All Welded Mobile Shelving .....	37-38

### Cantilever Shelving

Adjustable HD Heavy Duty Shelves .....	45
Adj. SB Solid Reinforced Shelves .....	45
Adjustable T-Bar Shelves .....	45
Free Standing Braces .....	45
Free Standing Uprights .....	45
Wall/Ceiling Uprights .....	46

### Wall Shelving

Heavy Duty Shelves .....	44
Inverted Shelves .....	44
Marine Edge Shelves .....	44
Microwave Shelves .....	44
Solid Wall Shelves .....	44
Slanted T-Bar Shelves .....	44
T-Bar Shelves .....	44
Wall Shelf with Pot Rack .....	44

## Specialty

Corner Guards .....	53
Merchandising Cart .....	26
Share Cart .....	26

## Stands

Cooking Equipment Stands .....	53-54
Counter Top Equipment Stands .....	1,4,53-54
Equipment Stands .....	21,53-54
Heavy Duty Stands .....	21,53-54
Mixer Stands-Mobile .....	21,53-54
Sandwich Rails .....	54
Slicer Stands - Mobile .....	21
Stainless Steel Top Stands .....	1,4,53
Utility Stands .....	1,4,21,53-54

## Tables

Accessories .....	52
-------------------	----

Boat Racks .....	52
Heavy Duty Tables .....	51
Meat Cutting Tables .....	51
Poly Top Tables .....	51
Prep Tables .....	51
Stainless Steel Top Tables .....	51
Utility Tables .....	51

## Trucks

Boxed Beef Truck .....	67
Bulk Carts - Frames & Tubs .....	60
Deck Trucks .....	66
Diamond Deck Trucks .....	66
Folding Trucks .....	65-66
Heavy Duty Stock Trucks .....	56,67
Low Boy Stock Trucks .....	65
Platform Trucks .....	66
Queen Marys .....	25
Transport .....	65-67
Tray Trucks .....	1-20
U-Boats .....	65-67
Uni-T Trucks .....	67
Utility Trucks .....	24

# HEALTHCARE

<b>Accessories</b> .....	<b>2,71</b>
--------------------------	-------------

## Baseboard

Cove Baseboard .....	53
----------------------	----

## Cabinets

Angle-Ledge Transport Cabinets .....	15
Clear Door Enclosed Cabinets .....	13-16
Delivery Cabinets .....	13-16
Economy "RAC line" Cabinets .....	14
Enclosed Transport Cabinets .....	13-16
Heavy Duty Cabinets .....	13-16
Room Service Cabinets .....	17
Universal Adjustable Angle Cabinets .....	15
Universal Enclosed Cabinet .....	15
Utility Cabinets .....	13-16

## Carts

2-Tier Carts .....	24,55-57
Bulk Carts - Frames & Tubs .....	60
Health Care Carts .....	6,12,17, 25
Linen Carts .....	25
Lug Carts .....	59-61
Mat Carts .....	68
Platter Carts .....	62-64
Queen Marys .....	25
Room Service Carts .....	17
Serving Carts .....	24, 32
Tray Delivery Carts .....	17-18,25
Tubular Deck Carts .....	56,65-67
Universal Carts .....	24,62
Utility Carts .....	24,32,55

# Table of Contents

## HEALTHCARE - Cont.

### Casters ..... 69-70

#### Dollies

Angle Dollies .....	27,29-31
Bowl Dollies.....	29
Bread Pan Dollies .....	30
Bun Pan Dollies.....	30
Chill Pac Dolly.....	27
Chilltray Dolly .....	27
Cup and Glass Dollies.....	28
Dish Rack Dollies.....	28
Food Box Dollies.....	27
Lug Dollies .....	32,59-61
Milk Crate Dollies .....	31
Mixer Bowl Dollies.....	29
Mixing Bowl Dollies .....	29
Oval Tray Dolly.....	30
Sheet Pan Dollies.....	30
Steamtable Pan Dolly.....	30
Super Dollies.....	31
Universal Dollies .....	31
Universal Lug Dollies .....	58

#### Miscellaneous

Drag Hook.....	30-31
Lugs .....	61
Tubs .....	60

### Product Options ..... 2,71

#### Racks

##### 12"x20" Pan Racks

End Loading - Standard Angle.....	6
End Loading - Double Deep .....	4
Half Size - Standard Angle .....	6
Lifetime Stepped Angle - Roll-In .....	12
Lifetime Stepped Angle .....	11
Lifetime Wide Angle - Roll-In .....	12
Lifetime Wide Angle.....	11
Refrigerator/Proofer - Wide Angle.....	3
Side Loading - Standard Angle.....	6
Steamtable .....	6
Universal Wide Angle .....	8,11
Universal Room Service Cart .....	17
Universal Stepped - Adjustable .....	9,15
Universal Stepped - Adjustable, Roll-In .....	9
Universal Stepped - Roll-In.....	8
Universal Stepped .....	8
Univ. Stepped Angle Cabinet - <i>Adjustable</i> .....	15
Wide Angle .....	8

##### 13"x18" & 14"x18" Pan Racks

Angle Ledge Transport Cabinet.....	15
Lifetime Stepped Angle - Roll-In .....	12
Lifetime Stepped Angle.....	11
Lifetime Wide Angle - Roll-In .....	12
Lifetime Wide Angle.....	11
Transport/Retrieval .....	6
Universal Room Service Cart .....	16

Universal Stepped - Adjustable .....	9
Universal Stepped - Adjustable, Roll-In .....	9
Universal Stepped - Roll-In.....	8
Universal Stepped .....	8
Univ. Stepped Angle Cabinet - <i>Adjustable</i> .....	15
Wide Angle .....	8

##### 15"x20" Tray Racks

End Loading - Standard Angle.....	4
Lifetime Stepped Angle - Roll-In .....	12
Lifetime Stepped Angle.....	11
Room Service Cart .....	17
Side Loading - Double Deep .....	4
Side Loading - Standard Angle .....	4
Tray Retrieval .....	6
Universal Stepped - Adjustable .....	9,15
Universal Stepped - Adjustable, Roll-In .....	9
Universal Stepped - Roll-In.....	8
Universal Stepped .....	8
Univ. Stepped Angle Cabinet - <i>Adjustable</i> .....	15

##### Bun Pan Racks

Bakery .....	1-3,5,7-12,20
Covers .....	2,71
Economy - All Welded.....	2,62
Economy - Knocked Down .....	2
Economy - Refrigerator/Proofer.....	3
Enclosed.....	13-16
Full Size - <i>End Loading</i> .....	1,2,4,5,7-12,63
Full Size - <i>End loading, Knocked down</i> .....	1,2
Full Size - Side Loading.....	1
Full Size - Side Loading, <i>Knocked down</i> .....	1
Half Size .....	1
Insert.....	9
Lifetime Series .....	10-13
Nesting "U" type.....	7
Nesting "Z" type.....	7
Oven .....	20
Proofer.....	3,8,9,11-12
Refrigerator/Proofer .....	3,8,9,12
Retarder.....	3,8,9,11-12
Roll-In .....	3,8,9,12
Sheet Pan .....	1-5, 7-12
Transport/Retrieval .....	6
Universal Stepped - Adjustable .....	9,15
Universal Stepped - Standard .....	8
Wide Angle .....	3,4,8

##### Can Racks

Economy Can Racks .....	34
First-In, First-Out Can Racks.....	34
Half Size Can Racks.....	33
Heavy Duty Can Racks.....	33-34
Mobile Can Racks .....	33-34

##### Dunnage Racks

Covers .....	35
Economy RAC Line Dunnage Racks.....	35
Heavy Duty Dunnage Racks.....	36
Lifetime Series Dunnage Racks .....	36
Mobile Dunnage Racks .....	35

##### Merchandise Racks

Display Racks.....	16,18
Slant Display Rack .....	16,18

##### Platter Racks

Double .....	63
Economy.....	63
Heavy Duty .....	64
Standard .....	63
Universal - Economy.....	62
Universal - Standard.....	62

##### Special Purpose Racks

Combo Racks .....	5
Display Racks .....	16,18
Food Box Racks .....	5,62
Glass Racks .....	28
Oval Tray Racks .....	4
Poly Box Racks .....	5,62
Pot & Pan Racks .....	19
Retrieval Racks .....	6
Slant Display Racks.....	16,18
Transport Racks .....	6
Tray Delivery Racks.....	6,13
Tray Drying Racks .....	23
Universal Oval Tray Racks .....	4,8
Utility Racks.....	1-17
Wall Mount Pan Racks .....	22

#### Shelving

##### Adjustable Shelving

Adjust-A-Shelf.....	39-41
Accessories .....	43
Dunnage Style Shelves .....	39,42
Economy RAC Line Shelves.....	42
HD Shelves.....	39,42
Louvered Shelves .....	40,42,47
Mobile Shelving .....	37-42
Posts.....	43
Pot & Pan Shelving.....	19
SB Shelves .....	41
Slatted Shelves.....	40,42,47
Solid Brute Shelves .....	41
Solid Reinforced Shelves .....	41
Solid Shelves.....	41,42
T-Bar Shelves .....	40,42,47

##### All Welded Shelving

All Welded Heavy Duty Shelving .....	37
All Welded T-Bar Shelving .....	38
All Welded Mobile Shelving .....	37-38

##### Cantilever Shelving

Adjustable HD Heavy Duty Shelves .....	45
Adjustable SB Solid Reinforced Shelves.....	45
Adjustable T-Bar Shelves .....	45
Free Standing Braces .....	45
Free Standing Uprights.....	45
Wall/Ceiling Uprights .....	46



# Table of Contents

## Wall Shelving

Heavy Duty Shelves .....	44
Inverted Shelves .....	44
Marine Edge Shelves .....	44
Microwave Shelves .....	44
Solid Wall Shelves .....	44
Slanted T-Bar Shelves .....	44
T-Bar Shelves .....	44
Wall Shelf with Pot Rack .....	44

## Specialty

Corner Guards .....	53
---------------------	----

## Stands

Cooking Equipment Stands .....	53-54
Counter Top Equipment Stands .....	1,4,53-54
Equipment Stands .....	21,53-54
Heavy Duty Stands .....	21,53-54
Mixer Stands-Mobile .....	21,53-54
Sandwich Rails .....	54
Slicer Stands - Mobile .....	21
Stainless Steel Top Stands .....	1,4,53
Utility Stands .....	1,4,21,53-54

## Tables

Accessories .....	52
Heavy Duty Tables .....	51
Poly Top Tables .....	51
Prep Tables .....	51
Stainless Steel Top Tables .....	51
Utility Tables .....	51

## Trucks

Bulk Cart - Frames & Tubs .....	60
Deck Trucks .....	66
Diamond Deck Trucks .....	66
Platform Trucks .....	66
Queen Marys .....	25
Tray Trucks .....	1-20

## MATERIAL HANDLING

<b>Accessories</b> .....	71
--------------------------	----

## Baseboard

Cove Baseboard .....	53
----------------------	----

## Carts

2-Tier Carts .....	24,55-57
Bulk Carts - Frames & Tubs .....	60
HD Multi-Shelf Carts, Stainless Steel .....	25
HD Multi-Shelf Carts, Aluminum .....	25
Low Boy Carts .....	65
Lug Carts .....	59-61
Mat Carts .....	68
Picking Carts .....	55,65-67
Platter Carts .....	62-64
Stocking Carts .....	24,55-56,65-67
Tubular Deck Carts .....	53,56,65-67
U-Boats .....	65-67
Universal Carts .....	24,59-60
Utility Carts .....	24, 55,65-67

<b>Casters</b> .....	69-70
----------------------	-------

## Dollies

Lug Dollies .....	32,59-61
Super Dollies .....	31
Universal Dollies .....	31
Universal Lug Dollies .....	61

## Miscellaneous

Drag Hook .....	30-32
Lugs .....	61
Tubs .....	60
Product Options .....	71

## Racks

Carrier Cart .....	20
Combo Racks .....	5
Covers .....	2,71
Insert Rack .....	9
Poly Box Storage Rack .....	5
Slant Display Rack .....	16
Transport/Retrieval .....	6
Universal Stepped .....	8
Universal Stepped - Adjustable .....	9
Universal Stepped - Roll-In .....	8
Wide Angle .....	8

## Platter Racks

Double Platter Racks .....	63
Economy Platter .....	63
Heavy Duty .....	64
Standard Platter Racks .....	63
Universal - Economy .....	62
Universal - Standard .....	62

## Special Purpose Racks

Carrier Racks .....	20
Combo Racks .....	5
Display Racks .....	16,18,22
Oval Tray Racks .....	4
Poly Box Racks .....	5,62
Retrieval Racks .....	6
Slant Display Racks .....	16
Transport Racks .....	6
Universal Oval Tray Racks .....	4,8
Utility Racks .....	5,6,8,9,16,20

<b>Security Cage</b> .....	50
----------------------------	----

<b>Security Fence</b> .....	49
-----------------------------	----

## Shelving

### Adjustable Shelving

Adjust-A-Shelf .....	39-41
Accessories .....	43
Dunnage Style Shelves .....	39,42
Economy RAC Line Shelves .....	42
HD Shelves .....	39,42

Louvered Shelves .....	40,42,47
Mobile Shelving .....	37-42
Posts .....	43
SB Shelves .....	41
Slatted Shelves .....	40,42,47
Solid Brute Shelves .....	41
Solid Reinforced Shelves .....	41
Solid Shelves .....	41,42
T-Bar Shelves .....	40,42,47

## All Welded Shelving

All Welded Heavy Duty Shelving .....	37
All Welded T-Bar Shelving .....	38
All Welded Mobile Shelving .....	37-38

## Cantilever Shelving

Adjustable HD Heavy Duty Shelves .....	45
Adjustable SB Solid Reinforced Shelves .....	45
Adjustable T-Bar Shelves .....	45
Free Standing Braces .....	45
Free Standing Uprights .....	45
Wall/Ceiling Uprights .....	46

## Wall Shelving

Heavy Duty Shelves .....	44
Inverted Shelves .....	44
Marine Edge Shelves .....	44
Solid Wall Shelves .....	44
T-Bar Shelves .....	44
Wall Shelf with Pot Rack .....	44

## Specialty

Corner Guards .....	53
---------------------	----

## Stands

Equipment Stands .....	53-54
Heavy Duty Stands .....	53-54
Stainless Steel Top Stands .....	53-54
Utility Stands .....	53-54

## Tables

Accessories .....	52
Boat Racks .....	52
Heavy Duty Tables .....	51
Meat Cutting Tables .....	51
Poly Top Tables .....	51
Prep Tables .....	51
Stainless Steel Top Tables .....	51
Utility Tables .....	51

## Trucks

Boxed Truck .....	67
Bulk Carts - Frames & Tubs .....	60
Deck Trucks .....	66
Diamond Deck Trucks .....	66
Folding Trucks .....	65-66
Folding Platform Trucks .....	65-66
Heavy Duty Stock Trucks .....	56,67
Low Boy Stock Trucks .....	65
Platform Trucks .....	66
Tiered Transport Trucks .....	25

# Table of Contents

## MATERIAL HANDLING- Cont.

Transport.....	65-67
U-Boats.....	65-67
Uni-T Trucks.....	67
Utility Trucks.....	65-66

## SUPERMARKET

<b>Accessories</b> .....	2,71
--------------------------	------

### Baseboard

Cove Baseboard .....	53
----------------------	----

### Cabinets

Angle-Ledge Transport Cabinets .....	15
Clear Door Enclosed Cabinets.....	13-16
Delivery Cabinets.....	13-16
Economy "RAC Line" Cabinets .....	14
Enclosed Transport Cabinets.....	13-16
Heavy Duty Cabinets .....	13-16
Universal Adjustable Angle Cabinets .....	15
Universal Enclosed Cabinets .....	15
Utility Cabinets .....	13-16

### Carts

2-Tier Carts .....	24,55-57
Bulk Carts - Frames & Tubs.....	60
Floral Cart .....	55
Low Boy Carts.....	65
Lug Carts.....	59-61
Mat Carts.....	68
Picking Carts.....	55-56,65-67
Platter Carts .....	62-64
Produce Carts .....	55-58
Produce Merchandiser.....	58
Stocking Carts.....	55-57,65-67
Tubular Deck Carts .....	55-57,65-67
U-Boats .....	65-67
Universal Carts.....	24,62
Utility Carts.....	24,32,55,65-66

<b>Casters</b> .....	69-70
----------------------	-------

### Dollies

Angle Dollies .....	27,29-31
Bread Pan Dollies .....	30
Chicken Dolly .....	31
Food Box Dollies .....	27
Lug Dollies .....	32,59-61
Milk Crate Dollies .....	31
Mixer Bowl Dolly .....	29
Mixing Bowl Dollies .....	29
Oval Tray Dolly .....	30
Sheet Pan Dollies.....	30
Steamtable Pan Dolly.....	30
Super Dollies.....	31
Universal Lug Dollies .....	61

### Miscellaneous

Drag Hook.....	30-32
Lugs .....	61
Tubs .....	60

<b>Product Options</b> .....	2,71
------------------------------	------

### Racks

#### 12"x20" Pan Racks

End Loading - Standard Angle.....	6
End Loading - Double Deep .....	4
Half Size - Standard Angle .....	6
Lifetime Stepped Angle - Roll-In .....	12
Lifetime Stepped Angle.....	11
Lifetime Wide Angle - Roll-In .....	12
Lifetime Wide Angle .....	11
Refrigerator/Proofer - Wide Angle.....	3
Side Loading - Standard Angle.....	6
Steamtable Rack .....	6
Universal Wide Angle .....	8,11
Universal Stepped - Adjustable .....	9
Universal Stepped - Adjustable, Roll-In .....	9
Universal Stepped - Roll-In.....	8
Universal Stepped .....	8
Univ. Stepped Angle Cabinet - Adjustable .....	15
Wide Angle .....	8

#### 13"x18" & 14"x18" Pan Racks

Angle Ledge Transport Cabinet.....	15
Lifetime Stepped Angle - Roll-In .....	12
Lifetime Stepped Angle.....	11
Lifetime Wide Angle - Roll-In .....	12
Lifetime Wide Angle .....	11
Transport/Retrieval .....	6
Universal Stepped - Adjustable .....	9
Universal Stepped - Adjustable, Roll-In .....	9
Universal Stepped - Roll-In.....	8
Universal Stepped .....	8
Univ. Stepped Angle Cabinet - Adjustable .....	15
Wide Angle .....	8

#### 15"x20" Tray Racks

End loading - Standard Angle.....	4
Lifetime Stepped Angle - Roll-In .....	12
Lifetime Stepped Angle.....	11
Side Loading - Double Deep .....	4
Side Loading - Standard Angle.....	4
Tray Retrieval .....	6
Universal Stepped - Adjustable .....	9,15
Universal Stepped - Adjustable, Roll-In .....	9
Universal Stepped - Roll-In.....	8
Universal Stepped .....	8
Univ. Angle Cabinet - Adjustable.....	15

#### Bun Pan Racks

Bakery .....	1-2,5,7,10-11,20
Covers .....	2,71
Economy - All Welded.....	2,64
Economy - Knocked Down .....	2
Economy - Refrigerator/Proofer.....	3

Enclosed Racks.....	13-16
Full Size - End Loading .....	1,2,4,5,7,8,9,10,11,64
Full Size - End loading, Knocked Down .....	1,2
Full Size - Side Loading.....	1
Full Size - Side Loading, Knocked Down .....	1
Half Size .....	1
Insert.....	9
Lifetime Series.....	10-13
Nesting "U" Type.....	7
Nesting "Z" Type .....	7
Oven .....	20
Proofer .....	3,8,9,12
Refrigerator/Proofer.....	3,8,9,12
Retarder.....	3,8,9,12
Roll-In .....	3,8,9,12
Sheet Pan .....	1-5, 7-12
Transport/Retrieval .....	6
Universal Stepped - Adjustable .....	9
Universal Stepped - Standard .....	8
Wide Angle .....	3,4,8

#### Can Racks

Economy Can Racks .....	34
First-In, First-Out Can Racks.....	34
Half Size Can Racks.....	33
Heavy Duty Can Racks.....	33-34
Mobile Can Racks .....	33

#### Dunnage Racks

Covers .....	35
Economy RAC Line Dunnages.....	35
Heavy Duty Dunnage .....	36
Lifetime Series Dunnage .....	36
Mobile Dunnage .....	35

#### Merchandiser Racks

Display .....	16,22,58
Folding Merchandiser .....	58
Mobile Merchandiser .....	58
Slant Display.....	16

#### Platter Racks

Double Platter.....	63
Economy.....	63
Heavy Duty .....	64
Standard .....	63
Universal - Economy.....	62
Universal - Standard.....	62

#### Special Purpose Racks

Catering Racks .....	20
Combo Racks .....	5
Display Racks.....	16,18,22
Food Box Racks .....	5,62
Glass Racks .....	28
Oval Tray Racks .....	4
Pizza Pan Racks .....	22
Poly Box Racks .....	5,62
Pot & Pan Racks .....	19
Slant Display Racks.....	16,18





# Table of Contents

Transport Racks ..... 6  
 Tray Drying Racks ..... 23  
 Universal Oval Tray ..... 4,8  
 Utility Racks ..... 1-17  
 Wall Mount Pan Racks ..... 22

**Security Cage** ..... 50

**Security Fence** ..... 49

## Shelving

### Adjustable Shelving

Accessories ..... 43  
 Adjust-A-Shelf ..... 39-41  
 Dunnage Style Shelves ..... 39,42  
 Economy RAC Line Shelves ..... 42  
 HD Shelves ..... 39,42  
 Louvered Shelves ..... 40,42,47  
 Mobile Shelving ..... 37-42  
 Posts ..... 43  
 Pot & Pan Shelving ..... 19  
 SB Shelves ..... 41  
 Slatted Shelves ..... 40,42,47  
 Solid Brute Shelves ..... 41  
 Solid Reinforced Shelves ..... 41  
 Solid Shelves ..... 41,42  
 T-Bar Shelves ..... 40,42,47

### All Welded Shelving

All Welded Heavy Duty Shelving ..... 37  
 All Welded T-Bar Shelving ..... 38  
 All Welded Mobile Shelving ..... 37-38

### Cantilever Shelving

Adjustable HD Heavy Duty Shelves ..... 45  
 Adjustable SB Solid Reinforced Shelves ..... 45  
 Adjustable T-Bar Shelves ..... 45  
 Free Standing Braces ..... 45  
 Free Standing Uprights ..... 45  
 Wall/Ceiling Uprights ..... 46

### Wall Shelving

Heavy Duty Shelves ..... 44  
 Inverted Shelves ..... 44  
 Marine Edge Shelves ..... 44  
 Microwave Shelves ..... 44  
 Solid Wall Shelves ..... 44  
 Slanted T-Bar Shelves ..... 44  
 T-Bar Shelves ..... 44  
 Wall Shelf with Pot Rack ..... 44

## Specialty

Corner Guards ..... 53

## Stands

Cooking Equipment Stands ..... 53-54  
 Counter Top Equipment Stands ..... 1,21,53-54  
 Equipment Stands ..... 21,53-54  
 Heavy Duty Stands ..... 21,53-54  
 Mixer Stands-Mobile ..... 21,53-54  
 Sandwich Rails ..... 54  
 Slicer Stands - Mobile ..... 21  
 Stainless Steel Top Stands ..... 1,53-54  
 Utility Stands ..... 21,53-54

## Tables

Accessories ..... 52  
 Boat Racks ..... 52  
 Heavy Duty Tables ..... 51  
 Meat cutting Tables ..... 51  
 Poly Top Tables ..... 51  
 Prep Tables ..... 51  
 Stainless Steel Top Stands ..... 50  
 Utility Tables ..... 51

## Trucks

Boxed Beef Truck ..... 67  
 Bulk Carts - Frames & Tubs ..... 60  
 Deck Trucks ..... 66  
 Diamond Deck Trucks ..... 66  
 Folding Platform Trucks ..... 66  
 Folding Trucks ..... 65-66  
 Heavy Duty Stock Trucks ..... 56,67  
 Low Boy Stock Trucks ..... 65  
 Multi-Shelf Trucks ..... 25  
 Platform Trucks ..... 66  
 Transport ..... 65-67  
 Tray Trucks ..... 1-20  
 U-Boats ..... 65-67  
 Uni-T Trucks ..... 67  
 Utility Trucks ..... 65-66



**For Current Product Lead Times**  
 visit our website at

**NewAgeIndustrial.com**

**1. Search**  
 Type in Model Number

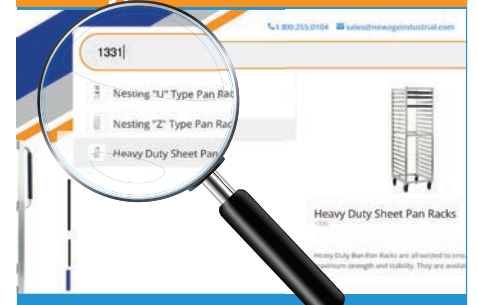

**2. Check Column**



# Pan Racks



1311

- All welded aluminum construction — No rivets.
- Units will hold 13" x 18", 14" x 18", and 18" x 26" pans.
- Four, one-inch welds per angle guide.
- Lifetime Guarantee against rust and corrosion, superior strength and durability guaranteed.
- NSF Certified.



## ▶ 1/2-Size Sheet Pan Rack

Model No.	Size W-H-D	Pan Capacity	Runner Spacing	Top Type	Ship Lbs.
<b>Under-Counter Size - End Loading</b>					
1313	20 <sup>3</sup> / <sub>8</sub> " x 32 <sup>1</sup> / <sub>4</sub> " x 26"	8	3"	Stainless	36
1314	20 <sup>3</sup> / <sub>8</sub> " x 32 <sup>1</sup> / <sub>4</sub> " x 26"	8	3"	None	27
<b>Bakery 1/2-Size with Poly Top - End Loading</b>					
95958	20 <sup>3</sup> / <sub>8</sub> " x 33 <sup>3</sup> / <sub>8</sub> " x 26"	5	4 1/2"	Poly	36
<b>Regular 1/2-Size - End Loading</b>					
1311	20 <sup>3</sup> / <sub>8</sub> " x 38" x 26"	10	3"	Stainless	42
1312	20 <sup>3</sup> / <sub>8</sub> " x 38" x 26"	10	3"	None	30
92096	20 <sup>3</sup> / <sub>8</sub> " x 38" x 26"	10	3"	Poly	42
1321	20 <sup>3</sup> / <sub>8</sub> " x 38" x 26"	6	5"	Stainless	35
1322	20 <sup>3</sup> / <sub>8</sub> " x 38" x 26"	6	5"	None	24
<b>Replacement Top - Not NSF Certified</b>					
45106	20 <sup>3</sup> / <sub>8</sub> " x 26"			Stainless	11
45256	20 <sup>3</sup> / <sub>8</sub> " x 26"			Aluminum	4

Four 5" stem type swivel casters.

**OPTIONS:** Options may not be NSF Certified. Contact the factory.

"CL(A)", "MD", "PS", "VB" - see page 71 for details.



All sheet pan racks quoted hold USA standardized 18 x 26" sheet pans (17<sup>7</sup>/<sub>8</sub> x 25<sup>7</sup>/<sub>8</sub>" actual). We are not responsible for pans that do not meet the industry standard, which may not fit our racks.

## ▶ Sheet Pan Rack - Heavy Duty

Model No.	Size W-H-D	Pan Capacity	Runner Spacing	Ship Lbs.
<b>3/4-Size End Loading Rack</b>				
1361	20 <sup>3</sup> / <sub>8</sub> " x 60 <sup>3</sup> / <sub>8</sub> " x 26"	17	3"	48
<b>End Loading Rack</b>				
1461*	20 <sup>1</sup> / <sub>16</sub> " x 69 <sup>3</sup> / <sub>4</sub> " x 26"	38	1 1/2"	56
1330	20 <sup>3</sup> / <sub>8</sub> " x 69 <sup>3</sup> / <sub>4</sub> " x 26"	30	2"	70
1331	20 <sup>3</sup> / <sub>8</sub> " x 69 <sup>3</sup> / <sub>4</sub> " x 26"	20	3"	56
1332	20 <sup>3</sup> / <sub>8</sub> " x 69 <sup>3</sup> / <sub>4</sub> " x 26"	15	4"	52
1333	20 <sup>3</sup> / <sub>8</sub> " x 69 <sup>3</sup> / <sub>4</sub> " x 26"	12	5"	48
1334	20 <sup>3</sup> / <sub>8</sub> " x 69 <sup>3</sup> / <sub>4</sub> " x 26"	10	6"	43
<b>Side Loading Racks</b>				
1461S*	28 <sup>3</sup> / <sub>8</sub> " x 69 <sup>3</sup> / <sub>4</sub> " x 19"	38	1 1/2"	48
1330S	28 <sup>3</sup> / <sub>8</sub> " x 69 <sup>3</sup> / <sub>4</sub> " x 19"	30	2"	58
1331S	28 <sup>3</sup> / <sub>8</sub> " x 69 <sup>3</sup> / <sub>4</sub> " x 19"	20	3"	50
1332S	28 <sup>3</sup> / <sub>8</sub> " x 69 <sup>3</sup> / <sub>4</sub> " x 19"	15	4"	46
1333S	28 <sup>3</sup> / <sub>8</sub> " x 69 <sup>3</sup> / <sub>4</sub> " x 19"	12	5"	46
1334S	28 <sup>3</sup> / <sub>8</sub> " x 69 <sup>3</sup> / <sub>4</sub> " x 19"	10	6"	46

Four 5" plate type swivel casters.

\* #1461 & #1461S Units hold pans by the lip only.

**OPTIONS:** Options may not be NSF Certified. Contact the factory.

**Standard Unit Options:**

"CL(B)", "B", "E", "M6", "MD", "VB", "PB", "PP(A)", "PS" - see page 71.

**Knocked Down Unit Options: Not NSF Certified**

**Knocked Down Units - Add "KD" suffix to model #.** (no charge)

Four 5" stem type swivel casters.

\*\*This option is not available for model #1461, #1461S or #1361.\*\*

"CL(A)", "VB" - see page 71 for details.



1461



1331S

- All units accommodate 13" x 18", 14" x 18", and 18" x 26" pans.
- Welded reinforced gussets keep the rack square.
- **Knocked Down Racks are not suitable for bagel applications.**
- Lifetime Guarantee against rust and corrosion, superior strength and durability guaranteed.
- NSF Certified.



All sheet pan racks quoted hold USA standardized 18" x 26" sheet pans (17<sup>7</sup>/<sub>8</sub> x 25<sup>7</sup>/<sub>8</sub>" actual). We are not responsible for pans that do not meet the industry standard, which may not fit our racks.

## ▶ Sheet Pan Rack - Standard

Model No.	Size W-H-L	Pan Capacity	Runner Spacing	Ship Lbs.
<b>All-Welded Units</b> - 5" plate type swivel casters.				
7331	20 <sup>3</sup> / <sub>8</sub> " x 69 <sup>3</sup> / <sub>4</sub> " x 26"	20	3"	45
<b>Options:</b> Options may not be NSF Certified. Contact the factory. "B", "CL(B)", "PB", "PS", "VB" - see page 71 for details.				
<b>All-Welded Units</b> - 5" stem type swivel casters.				
6330	20 <sup>3</sup> / <sub>8</sub> " x 69" x 26"	30	2"	50
6331	20 <sup>3</sup> / <sub>8</sub> " x 69" x 26"	20	3"	38
6333	20 <sup>3</sup> / <sub>8</sub> " x 69" x 26"	12	5"	33
<b>Options:</b> Options may not be NSF Certified. Contact the factory. "CL(A)", "PS", "VB" - see page 71 for details.				
<b>Knocked Down Units</b> - 5" stem type swivel casters.				
6300	20 <sup>3</sup> / <sub>8</sub> " x 69" x 26"	30	2"	49
6301	20 <sup>3</sup> / <sub>8</sub> " x 69" x 26"	20	3"	39
6303	20 <sup>3</sup> / <sub>8</sub> " x 69" x 26"	12	5"	32
<b>Options:</b> Options may not be NSF Certified. Contact the factory. "CL(A)", "VB" - see page 71 for details.				

- Accommodates 13" x 18", 14" x 18", and 18" x 26" sheet pans.



**!** All sheet pan racks quoted hold USA standardized 18" x 26" sheet pans (17<sup>7</sup>/<sub>8</sub>" x 25<sup>7</sup>/<sub>8</sub>" actual). We are not responsible for pans that do not meet the industry standard, which may not fit our racks.

## ▶ Sheet Pan Rack Options

See Page 71 For More Details.

- "B" - Corner Bumpers (4) - Add "B" suffix to the model #.
- "CL" - Caster Locks (2)
  - (A) 5" stem type swivel caster (7/16" dia) - Add "CL" suffix to the model #.
  - (B) 5" plate type swivel caster - Add "CL" suffix to the model #.
- "E" - Solid Base - Add "E" suffix to the model #.
- "M6" - Caster Upgrade - Add "M6" suffix to the model #.
- "MD" - Medical Caster Upgrade - Add "MD" suffix to the model #.
- "PB" - Perimeter Bumper - Add "PB" suffix to the model #.
- "PP" - Prison Package
  - (A) Tamper Resistant Screws - Add "PP" suffix to the model #.
- "PS" - Pan Stop - Add "PS" suffix to the model #.
- "VB" - Vertical Bumpers (4) - Add "VB" suffix to the model #.

1359 - Rack Cover (Clear, 12 mil) • 23"W x 64"H x 28"D  
Options may not be NSF Certified. Contact the factory.



# Pan Racks



1337



1336



## ▶ Refrigerator/Proofer Rack - Heavy Duty

Model No.	Size W-H-D	Pan Capacity	Runner Spacing	Ship Lbs.
<b>Standard Refrigerator/Proofer Racks</b>				
1337	20 <sup>3</sup> / <sub>8</sub> " x 64" x 26"	11	5"	45
1338	20 <sup>3</sup> / <sub>8</sub> " x 64" x 26"	18	3"	55
95433*	20 <sup>1</sup> / <sub>16</sub> " x 64 <sup>1</sup> / <sub>2</sub> " x 26"	36	1 <sup>1</sup> / <sub>2</sub> "	53
<b>Wide-Angle Refrigerator/Proofer Racks - Accepts 18" x 26" or 12" x 20" Pans</b>				
1335	20 <sup>3</sup> / <sub>8</sub> " x 64" x 26"	18	3"	72
1336	20 <sup>3</sup> / <sub>8</sub> " x 64" x 26"	11	5"	56

Four 5" plate type casters; two swivel, two swivel with brake.

**\* This Unit Holds Pans By The Lip Only. Not NSF Certified.**

**OPTIONS:** Options may not be NSF Certified. Contact the factory.

"B", "E", "PB", "PS", "VB" - see page 71 for details.

- Designed to accommodate 13" x 18", 14" x 18", and 18" x 26" pans. - Wide-Angle racks also accommodate 12" x 20" pans.
- Casters are inset, rolling within the perimeter of the base for easy loading and unloading.
- All welded aluminum construction... No rivets to loosen.
- Heavy duty, 5" plate type swivel casters, two with brake.
- Lifetime Guarantee against rust and corrosion.
- NSF Certified.

**!** All sheet pan racks quoted hold USA standardized 18" x 26" sheet pans (17<sup>7</sup>/<sub>8</sub>" x 25<sup>7</sup>/<sub>8</sub>" actual). We are not responsible for pans that do not meet the industry standard, which may not fit our racks.



95864



## ▶ Refrigerator/Proofer Rack - Standard

Model No.	Size W-H-D	Pan Capacity	Runner Spacing	Ship Lbs.
95864	20 <sup>3</sup> / <sub>8</sub> " x 63 <sup>3</sup> / <sub>16</sub> " x 26"	18	3"	35

Four 5" stem type swivel casters.

**Options:** Options may not be NSF Certified. Contact the factory.

"CL(A)", "PS", "VB" — see page 71 for details.

- Accommodates 13" x 18", 14" x 18", and 18" x 26" sheet pans.
- This rack is ideal for light- to medium-duty food service, bakery, and supermarket applications.
- Heavy duty, extruded angles provide easy product access and selection.

**!** All sheet pan racks quoted hold USA standardized 18" x 26" sheet pans (17<sup>7</sup>/<sub>8</sub>" x 25<sup>7</sup>/<sub>8</sub>" actual). We are not responsible for pans that do not meet the industry standard, which may not fit our racks.

## ▶ Oval Tray Rack

Model No.	Size W-H-D	Tray Capacity	Tray Size	Angle Spacing	Ship Lbs.
<b>Standard Units - Accepts Various Oval Trays</b>					
NS893	24¾" x 69¾" x 27½"	10	22" x 26⅞"	6"	57
95681	24¾" x 63¾" x 27½"	9	22" x 26⅞"	6"	54
95048	26⅞" x 69¾" x 30"	10	23½" x 29"	6"	62
Four 5" plate type swivel casters.					
<b>Universal - Accepts various oval trays, 18" x 26" and 12" x 20" pans.</b>					
96058	26½" x 70⅞" x 30"	10	See Below	6"	99
<b>Universal Units (#96058 &amp; #97690) accept oval tray sizes 22¾" x 27⅞", 20¾" x 25½", and 23½" x 29".</b>					

Four 5" plate type swivel casters.

**Options:** Options may not be NSF Certified. Contact the factory.

"B", "CL(B)", "M6", "PB", "PS", "VB" - see page 71 for details.

- Handles most oval tray sizes.
- Ideal for serving large parties and banquets.
- Gussets are welded in all corners to prevent "racking".
- Four, one inch welds per angle guide.
- Lifetime Guarantee against rust and corrosion.
- NSF Certified.



96058

95681



## ▶ 15" x 20" Tray Rack

Model No.	Size W-H-D	Pan Capacity	Runner Spacing	Ship Lbs.
<b>Side Loading Unit</b>				
NS833	23⅞" x 69" x 30½"	24	5"	41
<b>End Loading Unit</b>				
NS832	17⅞" x 69" x 21"	12	5"	32
<b>Side Loading Unit - Double Deep with Stainless Steel Top</b>				
NS834	23⅞" x 38" x 30"	12	5"	42
<b>Side Loading Unit - Double Deep, No Top</b>				
NS834A	23⅞" x 38" x 30"	12	5"	30

Four 5" stem type swivel casters.

**Options:** Options may not be NSF Certified. Contact the factory.

"CL(A)", "E", "MD", "PS", "VB" — see page 71 for details.

**52038 Vinyl Cover for #NS832 - Not NSF Certified.**  
green vinyl cover with (4) zippers

- Specifically designed for 15" x 20" trays.
- Extra gussets are welded in all corners to prevent "racking". — All welded construction.
- Four, one inch welds per angle guide.
- Lifetime Guarantee against rust and corrosion.
- NSF Certified.



NS834A

NS833



# Pan Racks



1481



92052



## ► Poly Box Storage Rack

Model No.	Size W-H-D	Poly Box Capacity	Runner Spacing	Ship Lbs.
<b>End Loading - Accepts 18" x 26" or 18" x 13" Poly Food Boxes</b>				
1481	20 <sup>3</sup> / <sub>16</sub> " x 70 <sup>1</sup> / <sub>4</sub> " x 26"	8	7 <sup>1</sup> / <sub>2</sub> "	42
NS648	20 <sup>7</sup> / <sub>16</sub> " x 70 <sup>3</sup> / <sub>4</sub> " x 26"	16	3 <sup>1</sup> / <sub>2</sub> "	53
92052	20 <sup>7</sup> / <sub>16</sub> " x 71 <sup>3</sup> / <sub>4</sub> " x 26"	12	5"	48

Four 5" plate type casters; two swivel, two swivel with brake.

Designed to accommodate 13" x 18" and 18" x 26" poly food boxes, with or without a lid. Compatible with boxes manufactured by Cambro®, Carlisle®, Continental®, or Rubbermaid®.

Rack capacity is determined by the depth of the box.

**THESE UNITS WILL NOT HOLD 18" x 26" BUN PANS.**

**Options:** Options may not be NSF Certified. Contact the factory.

"B", "E", "M6", "MD", "PB", "PS", "VB" — see page 71 for details.

- Transport food boxes with one rack.
- Unique "C" channel design holds boxes securely (with or without lid)... Even when pulled partly out.
- **All welded aluminum construction with 5" plate type casters.**
- Lifetime Guarantee against rust and corrosion.
- NSF Certified.

## ► Poly Box/Sheet Pan Combination Rack

Model No.	Size W-H-D	Pan Capacity	Runner Spacing	Ship Lbs.
1482	20 <sup>3</sup> / <sub>8</sub> " x 69 <sup>3</sup> / <sub>4</sub> " x 26"	11	5"	44
1484	20 <sup>3</sup> / <sub>8</sub> " x 69 <sup>3</sup> / <sub>4</sub> " x 26"	16	3 <sup>1</sup> / <sub>2</sub> "	47
1486	20 <sup>3</sup> / <sub>8</sub> " x 69 <sup>3</sup> / <sub>4</sub> " x 26"	8	7 <sup>1</sup> / <sub>2</sub> "	40

Four 5" plate type casters; two swivel, two swivel with brake.

Capacities listed are the maximum number of 18" x 26" pans each unit will hold. Box capacity is determined by the depth of the box, as well as the guide spacing. Deeper boxes may block the guides, reducing the capacity of the rack.

**Options:** Options may not be NSF Certified. Contact the factory.

"B", "E", "M6", "PB", "PS", "VB" - see page 71 for details.

- Transport food boxes and 18" x 26" sheet pans with one rack.
- Utilize vertical storage space by handling multiple poly food boxes and trays with one rack.
- **All welded aluminum construction with 5" plate type casters.**
- Lifetime Guarantee against rust and corrosion.
- NSF Certified.



1482



1484



## ▶ Steamtable Pan Rack

Model No.	Size W-H-D	Pan Capacity	Runner Spacing	Ship Lbs.
<b>½-Size Rack w/ Stainless Steel Top — Side Loading</b>				
1501	24¼" x 35" x 27¾"	16	3"	42

Four 5" stem type swivel casters.

**Options:** Options may not be NSF Certified. Contact the factory.

"CL(A)", "E", "MD", "PS", "VB" — see page 71 for details.

<b>Full Size - End Loading Unit</b>				
52199 *	16¼" x 69" x 22¾"	10	5"	31
1505	16¼" x 69" x 22¾"	18	3"	42

Four 5" stem type swivel casters.

**Options:** Options may not be NSF Certified. Contact the factory.

"CL(A)", "E", "MD", "PS", "VB" — see page 71 for details.

<b>Full Size - Side Loading Units</b>				
1507	23¾" x 69¾" x 27"	20	5"	45
1509	23¾" x 69¾" x 27"	36	3"	52

Four 5" plate type swivel casters.

**\* 52199 Not NSF Certified.**

**Options:** Options may not be NSF Certified. Contact the factory.

"CL(B)", "E", "MD", "PS", "PB", "VB" — see page 71 for details.

- Transports a large number of pans and product.
- Gussets are welded in all corners to prevent "racking".
- **Designed especially for 12" x 20" steamtable/hotel pans.**
- Units with stem type casters have reinforced channel inserts to increase durability.
- Four, one inch welds per angle guide.
- Lifetime Guarantee against rust and corrosion.
- NSF Certified. (Excluding Item 52199)



52199



1509



## ▶ Transport/Retrieval Rack

Model No.	Size W-H-D	Tray Capacity	Angle Spacing	Ship Lbs.
<b>Tray Retrieval Rack</b>				
97743	20¾" x 69½" x 30"	*	5"	54
* Tray Capacity = (24) 14" x 18" Trays • (12) 18" x 26" Trays				
97744	22½" x 69½" x 30"	**	5"	57
** Tray Capacity = (24) 15" x 20" Trays				
97745	20¾" x 69½" x 30"	***	5"	65
*** Tray Capacity = (24) 14" x 18" Trapezoid Trays / Round Trays				

Four 5" plate type swivel casters.

**Options:** Options may not be NSF Certified. Contact the factory.

"B", "CL(B)", "E", "M6", "MD", "PB", "PS", "VB" — see page 71 for details.



97745



97744



# Pan Racks

## ▶ Nesting Pan Rack - "Z" Type



1331Z

51107



Model No.	Size W-H-D	Pan Capacity	Runner Spacing	Ship Lbs.
<b>½-Size Nesting "Z" Pan Rack - Not NSF Certified.</b>				
51107*	20½" x 31½" x 26"	8	3"	39
<b>Full-Size Nesting "Z" Pan Racks</b>				
1330Z	20¾" x 69¾" x 26"	30	2"	86
1331Z	20¾" x 69¾" x 26"	20	3"	68
1332Z	20¾" x 69¾" x 26"	15	4"	61
1333Z	20¾" x 69¾" x 26"	12	5"	57
<b>Roll-In Nesting "Z" Pan Racks - Not NSF Certified.</b>				
99866*	20¾" x 64¾" x 26"	18	3"	65
97379*	20¾" x 64¾" x 26"	11	5"	60

Four 5" plate type swivel casters.

Designed to accommodate 13" x 18", 14" x 18" and 18" x 26" pans.

\* Not NSF Certified.

Options: Options may not be NSF Certified. Contact the factory.

"CL(B)", "MD", "VB" — see page 71 for details.

6 "Z" Racks = 14.9 sq/ft • 6 Standard Racks = 22.4 sq/ft

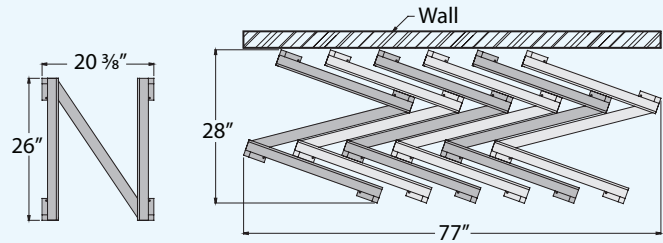

**!** All sheet pan racks quoted hold USA standardized 18" x 26" sheet pans (17⅞" x 25⅞" actual). We are not responsible for pans that do not meet the industry standard, which may not fit our racks.

## ▶ Nesting Pan Rack - "U" Type



1330U



Model No.	Size W-H-D	Pan Capacity	Runner Spacing	Ship Lbs.
1330U	20¾" x 69¾" x 26"	30	2"	77
1331U	20¾" x 69¾" x 26"	20	3"	66

Four 5" plate type swivel casters.

Designed to accommodate 13" x 18", 14" x 18" and 18" x 26" pans.

Options: Options may not be NSF Certified. Contact the factory.

"CL(B)", "MD", "PS", "VB" -- see page 71 for details.

6 "U" Racks = 13.8 sq/ft • 6 Standard Racks = 22.4 sq/ft

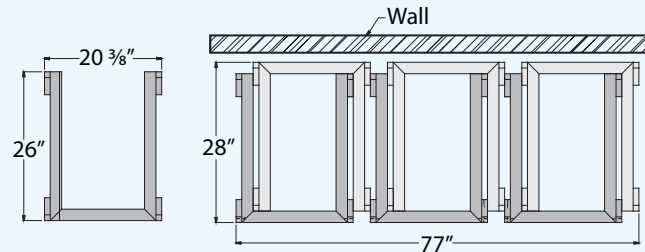



## ► Universal Stepped-Angle Rack

Model No.	Size W-H-D	Pan Slides	Runner Spacing	Ship Lbs.
<b>Universal Stepped-Angle Racks</b>				
1640	24½" x 70⅞" x 26"	13 pair	4½"	90
1642	24½" x 71⅞" x 26"	20 pair	3"	156
<b>Universal Roll-In Stepped-Angle Racks</b>				
1635	24½" x 64½" x 25¼"	12 pair	4½"	82
1637	24½" x 64½" x 25¼"	18 pair	3"	109

Four 5" plate type swivel casters.

**All Welded Unit • Angle Runners Are NOT ADJUSTABLE**

**Options:** Options may not be NSF Certified. Contact the factory.

"CL(B)", "B", "VB", "PS", "PB", "E" — see pg 71 for details.

### PAN SIZES:

10" x 20" Roast & Bake Pans • 20" x 22" Roast & Bake Pans • 18" x 26" Roasting Pans • 18" x 26" Bun Pans • 18" x 13" Bun Pans • 12" x 20" Steam Table Pans • 20¾" x 25½" European Std. Gastr-Norm Pans • 15" x 20" Service Tray • 14" x 18" Service Tray • 20" x 20" Cup & Glass Racks



1635



1642

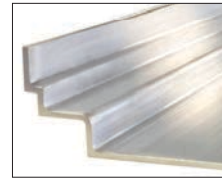

Stepped-Angle Profile



## ► Wide Angle Rack

Model No.	Size W-H-D	Pan Slides	Runner Spacing	Ship Lbs.
<b>Wide Angle - Accepts 18" x 26" or 12" x 20" Pans - NSF Certified.</b>				
1305	20¾" x 69¾" x 26"	12 pair	5"	56
1306	20¾" x 69¾" x 26"	20 pair	3"	72
<b>Extra-Wide Angle - Accepts 18" x 26" or 12" x 20" Pans, and Various Oval Trays.</b>				
96058	26½" x 70⅞" x 30"	10 pair	6"	99

Four 5" plate type swivel casters.

**Options:** Options may not be NSF Certified. Contact the factory.

"B", "CL(B)", "E", "M6", "MD", "PB", "PP(A)", "PS", "VB" -- see page 71 for details.

- Mix-and-match pans to meet your needs.

### Wide Angle Racks (1305 & 1306)

- Accommodates 13" x 18", 14" x 18", and 18" x 26" sheet pans, as well as 12" x 20" steamtable pans (by the lip).

### Extra-Wide Angle Racks (96058 & 97690)

- Accommodates 13" x 18", 14" x 18", and 18" x 26" sheet pans. 12" x 20" and 20" x 26" steamtable pans, as well as several sizes of oval trays (by the bottom)..

- Welded, reinforced gussets keep the rack square under heavy loads.
- Four, one inch welds per angle guide.
- NSF Certified.



1305



Extra Wide Angle | 96058 & 97690

96058

# Pan Racks



1650

## ► Universal Adjustable Stepped Angle Rack

Model No.	Size W-H-D	Number Of Runners	Minimum Spacing	Ship Lbs.
<b>Roll-In Unit</b>				
1650	24½" x 64" x 26"	12 pair	1 ½"	82
<b>Standard Unit</b>				
1655	24½" x 70" x 26"	13 pair	1 ½"	89
<b>Additional Angle Runner</b>				
42068				2

Four 5" plate type swivel casters.  
Bottom pan guides are welded in place.

**Options:** Options may not be NSF Certified. Contact the factory.  
"B", "CL(B)", "E", "PB", "PS", "VB" - see page 71 for details.

- Heavy duty utility racks for the transport and storage of product on a large variety of pans. [See page 8 for pan sizes \(Universal Stepped Angle Rack\).](#)
- All welded aluminum frame with adjustable universal angles on 1½" centers.
- Roll-in unit fits pass-through refrigerators, freezers, and warming cabinets with inset 5" swivel casters.
- Lifetime Guarantee against rust and corrosion.



1612



1610

## ► Insert Rack

Model No.	Size W-H-D	Pan Capacity	Angle Spacing	Ship Lbs.
<b>½-Size Unit - Holds 18" x 26" (Full Size) Sheet Pans</b>				
1610	20¾" x 23" x 24"	7	3"	14
<b>Full Size Unit - Holds 18" x 26" (Full Size) Sheet Pans</b>				
1612	20¾" x 51" x 24"	16	3"	28
97729	20¾" x 51" x 24"	24	2"	35
<b>½-Size Unit - Steamtable - Holds 12" x 20" Steamtable Pans</b>				
97073 *	15⅞" x 23¼" x 22"	7	3"	25

**Fits most reach-ins • Requires 21" door clearance.**

**\* Not NSF Certified.**

**Options:** Options may not be NSF Certified. Contact the factory.  
"PS" - see page 71 for details.

- All-welded aluminum frame.
- Lifetime Guarantee against rust and corrosion.



# Lifetime Series Sheet Pan Racks



Unequalled in construction, Lifetime Series Racks features ergonomically-friendly “D” tube uprights with heavy-duty, ribbed angle guides. Cross-braces are one-inch square tube, secured to vertical uprights and bolstered with a heavy angle gusset at the junction. The all welded base is reinforced at the corners with threaded plates that casters are bolted to, no holes in the framework that compromise the integrity of the rack.

Designed to endure the rigors of around-the-clock usage, these units are ideal for use in the Foodservice, Hospitality, and Healthcare industries, including correctional and educational institutions.

- Ergonomic uprights feature a user-friendly radius that’s easy to grip.
- Runners are ribbed, allowing pans to slide on and off with ease, minimizing the galling or flaking that can occur with heavy usage.
- Equipped with four heavy duty, 6" x 2" plate type swivel casters, - Polyurethane tread provides excellent control.
- K-Urethane Caster upgrade available, with or without brakes.
- NSF Certified.



4331



All LIFETIME SERIES products carry a LIFETIME Guarantee against rust and corrosion as well as a LIFETIME Guarantee against material defects and workmanship.



## ★ Sheet Pan Rack

Model No.	Size W-H-D	Pan Capacity	Angle Spacing	Ship Lbs.
4330	21½" x 73" x 26"	30	2"	86
4331	21½" x 73" x 26"	20	3"	83
4332	21½" x 73" x 26"	15	4"	75
4333	21½" x 73" x 26"	12	5"	66

Four 6" x 2" plate type swivel casters.

Designed to accommodate 13" x 18", 14" x 18" and 18" x 26" pans.

**Options:** Options may not be NSF Certified. Contact the factory.

"B", "CL(C)" - Standard Casters, "E", "PB", "PP(A)", "PS"

— see page 71 for details.

**Caster Upgrade** — Add "KU" suffix to model #.

(Four 6" plate type K-Urethane swivel casters.)

**Optional Caster Locks for Upgrade** - "CL(D)" — see page 71 for details.



- Heavy Duty, 6" x 2" plate type, swivel casters allow for maximum mobility.



- Ergonomic uprights feature a comfortable radius that is easy on user's hands.



All sheet pan racks quoted hold USA standardized 18" x 26" sheet pans (17⅞" x 25⅞" actual). We are not responsible for pans that do not meet the industry standard, which may not fit our racks.



# Lifetime Series Wide-Angle Racks



4340

Accommodate a **WIDE** variety of pan sizes and styles with **ONE** rack. Mix-and-Match pan types to meet your needs! Our lifetime series racks can handle heavy loads with ease.

Designed for institutional, correctional, casino, hotel, university and hospital use — Ideal for facilities that require a durable rack to meet the needs of their around-the-clock usage.

- Ergonomically friendly radius uprights with reinforcing cross bars.
- Heavy Duty, 6" x 2" plate type casters allow for maximum mobility.
- NSF Certified.



All LIFETIME SERIES products carry a LIFETIME Guarantee against rust and corrosion as well as a LIFETIME Guarantee against material defects and workmanship.



## ★ Wide-Angle Pan Rack | Stepped-Angle Pan Rack



### Wide-Angle Pan Racks

#4339 - 20 sets of angle runners  
#4340 - 12 sets of angle runners



### Stepped-Angle Pan Racks

#4640 - 13 sets of angle runners  
#4642 - 20 sets of angle runners

Model No.	Size W-H-D	Angle Spacing	Ship Lbs.
<b>Wide-Angle Pan Racks</b>			
4339	21½" x 73" x 26"	3"	99
<i>Pan Capacity = (20) 18" x 26", (19) 12" x 20", (40) 13" x 18", (40) 14" x 18"</i>			
4340	21½" x 73" x 26"	5"	81
<i>Pan Capacity = (12) 18" x 26", (11) 12" x 20", (24) 13" x 18", (24) 14" x 18"</i>			
<b>Stepped-Angle Pan Racks</b>			
4640	25" x 73" x 26"	4 ½"	142
4642	25" x 73" x 26"	3"	1587

Four 6" x 2" plate type swivel casters.

**Accepts:** Roast & Bake Pans 20" x 22", 18" x 26" & 10" x 20", Steamtable Pans 12" x 18" & 12" x 20", Bun Pans 18" x 13" & 18" x 26", Service Trays 15" x 20" & 14" x 18", Maxi Pan 20¾" x 25½", Standard GastroNorm Pans 20¾" x 25½"

**Note:** Angle Runners Are NOT ADJUSTABLE.

**Options:** Options may not be NSF Certified. Contact the factory.

"B", "CL(C)" standard, "CL(D)" upgrade, "E", "PB", "PP(A)", "PS" - see page 71.

**Caster Upgrade** — Add "KU" suffix to model #.  
(Four 6" plate type K-Urethane swivel casters.)

# Lifetime Series Roll-In Racks



Roll-In Racks feature the same superior Lifetime Series construction, shortened to fit roll-in freezers, proofers, refrigerators, and retarders.

Designed for institutional, correctional, casino, hotel, university and hospital use — Ideal for facilities that require a durable rack to meet the needs of their around-the-clock usage.

- Casters are inset, swiveling within the perimeter of the rack.
- Two full welds on every angle connection — The most in the industry.
- NSF Certified.



4635



All LIFETIME SERIES products carry a LIFETIME Guarantee against rust and corrosion as well as a LIFETIME Guarantee against material defects and workmanship.



## ★ Wide-Angle Roll-In Rack | Stepped-Angle Roll-In Rack

Model No.	Size W-H-D	Angle Spacing	Ship Lbs.
<b>Wide-Angle Roll-In Racks</b>			
4337 **	21½" x 64" x 26"	5"	74
<i>Pan Capacity = (11) 18" x 26", (10) 12" x 20", (22) 13" x 18", (22) 14" x 18"</i>			
4338	21½" x 64" x 26"	3"	80
<i>Pan Capacity = (18) 18" x 26", (17) 12" x 20", (36) 13" x 18", (36) 14" x 18"</i>			
<b>Stepped-Angle Roll-In Racks</b>			
4635	25" x 64" x 26"	4 ½"	84
4637	25" x 64" x 26"	3"	118

Four 5" x 2" plate type swivel casters.

\*\* Top angle clearance is 4¼".

**Accepts:** Roast & Bake Pans 20"x22", 18"x26" & 10"x20", Steamtable Pans 12"x18" & 12"x20", Bun Pans 18"x13" & 18"x26", Service Trays 15"x20" & 14"x18", Maxi Pan 20¾"x25½", Standard GastroNorm Pans 20¾"x25½"

**Note:** Angle Runners Are NOT ADJUSTABLE

**Options:** Options may not be NSF Certified. Contact the factory.

"B", "CL(B)", "E", "PB", "PP(A)", "PS" — see page 71 for details.



**Wide-Angle Roll-In Racks**

#4337 - 11 sets of angle runners  
#4338 - 18 sets of angle runners



**Stepped-Angle Roll-In Racks**

#4635 - 12 sets of angle runners  
#4637 - 18 sets of angle runners



# Lifetime Series Transport Cabinet



## Our Lifetime Series Transport Cabinet is the toughest in the industry!

Unequalled in construction, this unit is designed to keep product safe and endure around-the-clock usage, including (relentless) truck loading and off-loading. Ideal for use in the foodservice, hospitality, and healthcare industries, including correctional facilities and educational institutions.

- Solid side panels are composed of interlocking aluminum extrusions with guides spaced on 1½" centers for maximum capacity.
- Air circulates top to bottom via a chimney effect created by the formed back panel and panel insert, welded to the reinforced door framework.
- Internal tie rods and a tubular skeleton provide additional strength and durability.
- Tubular supports and inset plates are welded to the solid sheet base; the plates are threaded for bolting casters onto the cabinet, no holes in the framework or base!
- Call the factory to substitute for a (clear) polycarbonate door panel.
- Stainless steel hinges allow the door to open 270 degrees and the flip-down latch clinches the door closed. Available door latch holds the door open and out of the way for efficient loading.
- NSF Certified.

1290WDW



All LIFETIME SERIES products carry a LIFETIME Guarantee against rust and corrosion as well as a LIFETIME Guarantee against material defects and workmanship.



Interlocking aluminum extrusions with guides spaced on 1½" centers



Reinforced center supports.



Door Latch

## ★ Transport Cabinet

Model No.	Size W-H-D	Pan Cap.	H.D. Base	Ship Lbs.
<b>Full Size Enclosed Pan Rack — 1½" Runner Spacing</b>				
1290WDW	20¾" x 69" x 27¾"	38	Yes	168

Four 6" x 2" K-Urethane plate type swivel casters.

**Equipped with heavy reinforced door.**

Units hold 13" x 18", 14" x 18", and 18" x 26" pans by the lip.

**Options:** Options may not be NSF Certified. Contact the factory.

"B", "CL(D)", "DL", "PB" - see page 71 for details.

**Clear Polycarbonate Door** - Add "CD" suffix to model #.



All sheet pan racks quoted hold USA standardized 18" x 26" sheet pans (17¾" x 25¾" actual). We are not responsible for pans that do not meet the industry standard, which may not fit our racks.

## ► Enclosed Transport Cabinet - Heavy Duty

### Sheet Pan / Bun Pan Enclosed Cabinets

Model No.	Size W-H-D	Casters	Pan Capacity	H.D. Base	Ship Lbs.
<b>½-Size Enclosed Pan Rack — 1½" Runner Spacing</b>					
1296	20 <sup>7</sup> / <sub>8</sub> " x 38" x 27 <sup>5</sup> / <sub>8</sub> "	5"	20	No	103
<b>¾-Size Enclosed Pan Rack — 1½" Runner Spacing</b>					
1293	20 <sup>7</sup> / <sub>8</sub> " x 56" x 27 <sup>5</sup> / <sub>8</sub> "	5"	32	Yes	132
<b>Full Size Enclosed Pan Rack — 1½" Runner Spacing</b>					
1290	20 <sup>7</sup> / <sub>8</sub> " x 68" x 27 <sup>5</sup> / <sub>8</sub> "	5"	40	Yes	159
1292*	20 <sup>7</sup> / <sub>8</sub> " x 69" x 27 <sup>5</sup> / <sub>8</sub> "	6"	38	Yes	158
<b>Solid Sides, Open Ends, Solid Top &amp; Bottom — 1½" Spacing</b>					
1291	20 <sup>7</sup> / <sub>8</sub> " x 68" x 27 <sup>5</sup> / <sub>8</sub> "	5"	40	Yes	86
<b>Solid Sides, Open Ends - Top &amp; Bottom — 1½" Runner Spacing</b>					
96328	20 <sup>5</sup> / <sub>16</sub> " x 69 <sup>13</sup> / <sub>16</sub> " x 26 <sup>1</sup> / <sub>2</sub> "	5"	39	N/A	82

#### Casters:

5" x 1<sup>3</sup>/<sub>8</sub>" polyurethane plate type swivel caster.

6" x 2" polyurethane plate type swivel caster.

\* Equipped With A Reinforced Door — Standard

Units hold 13" x 18", 14" x 18", and 18" x 26" pans by the lip.

### Steamtable Pan Enclosed Cabinet

Model No.	Size W-H-D	Casters	Pan Capacity	H.D. Base	Ship Lbs.
<b>Steamtable Pan Enclosed Cabinet — 1½" Runner Spacing</b>					
95141	23 <sup>3</sup> / <sub>4</sub> " x 69" x 27 <sup>3</sup> / <sub>8</sub> "	5"	24	Yes	166

Unit holds 12" x 20" steamtable pans (4" deep). **Not NSF Certified.**

**Options:** Options may not be NSF Certified. Contact the factory.

"B", "MD" (excluding #1292), "PB", "CL(B)", "CL(C)" -- See page 71 for details.

**Clear Polycarbonate Door** - Add "CD" suffix to model #.

**Open Door Latch** - Add "DL" suffix to model #.

**Reinforced Door** - Add "RD" suffix to model #.

Note: #1292 comes equipped with a reinforced door - standard.

**Prison Package** - Add "PP(B)" suffix to model # (#1290, #1293, & #1296 only).

(4) Welded Hinges

(4) 6" Casters

(2) Padlock Holes In Door

(+) Extra Interior Bracing

(+) Tamper-Proof Screws & Bolts

\*\*\* 38 Pan Capacity \*\*\*



1290



1290CD

Shown with optional Clear Polycarbonate Door



## ► Enclosed Transport Cabinet - Standard

Model No.	Size W-H-D	Pan Capacity	Runner Spacing	Ship Lbs.
1290A	20 <sup>7</sup> / <sub>8</sub> " x 68" x 27 <sup>5</sup> / <sub>8</sub> "	40	1 ½"	134

Four 5" plate type swivel casters.

Units hold 13" x 18", 14" x 18", and 18" x 26" pans by the lip.

**Options:** Options may not be NSF Certified. Contact the factory.

"B", "CL(B)", "PB" — See page 71 for details.

**Clear Polycarbonate Door** - Add "CD" suffix to model #.

**Open Door Latch** - Add "DL" suffix to model #.

**Reinforced Door** - Add "RD" suffix to model #.



1290A



All sheet pan racks quoted hold USA standardized 18" x 26" sheet pans (17<sup>7</sup>/<sub>8</sub>" x 25<sup>7</sup>/<sub>8</sub>" actual). We are not responsible for pans that do not meet the industry standard, which may not fit our racks.

# Enclosed Cabinets



97243CDCLPB



## ▶ Angle-Ledge Transport Cabinet

Model No.	Size W-H-D	Runner Spacing	H.D. Base	Reinforced Door	Tie Rod	Ship Lbs.
97243	21" x 69½" x 29⅝"	5"	Yes	Yes	1	156
Pan Capacity: (12) 18" x 26" • (24) 14" x 18" • (24) 13" x 18"						
97718	21" x 69½" x 29⅝"	3"	Yes	Yes	2	162
Pan Capacity: (20) 18" x 26" • (40) 14" x 18" • (40) 13" x 18"						

Four 5" plate type swivel casters.

**Also Available With Other Angle Spacing Options, Call Factory For Quote.**

**Options:** Options may not be NSF Certified. Contact the factory.

"B", "CL(B)", "M6", "MD", "PB" -- See page 71 for details.

**Open Door Latch** - Add "DL" suffix to model #.

**Clear Polycarbonate Door** - Add "CD" suffix to model #.

**!** All sheet pan racks quoted hold USA standardized 18" x 26" sheet pans (17⅞" x 25⅞" actual). We are not responsible for pans that do not meet the industry standard, which may not fit our racks.



97746



## ▶ Universal Adjustable Angle Cabinet

Model No.	Size W-H-D	Angle Spacing	Angle Runners	H.D. Base	Ship Lbs.
97746	27⅞" x 61½" x 30⅞"	Adj.	11 pair	Yes	255
97747	27⅞" x 70½" x 30⅞"	Adj.	13 pair	Yes	243
<b>Additional Angle Runner</b>					
42078					2.25

Four 5" plate type swivel caster.

**Angle Runners are adjustable on 1½" centers.**

**Standard equipped with Reinforced Door.**

**Pan Sizes:** 10" x 20" Roast and Bake Pans • 20" x 22" Roast & Bake Pans • 18" x 26" Roasting Pans  
18" x 26" Bun Pans • 18" x 13" Pans • 12" x 20" Steam Table Pans • 20 ¾" x 25 ½" European Standard  
GastroNorm Pans • 15" x 20" Service Tray • 14" x 18" Service Tray • 20" x 20" Cup & Glass Racks

**Options:** Options may not be NSF Certified. Contact the factory.

"B", "CL(B)", "M6", "MD", "PB" — See page 71 for details.

**Open Door Latch** - Add "DL" suffix to model #.

**Clear Polycarbonate Door** - Add "CD" suffix to model #.

**!** All sheet pan racks quoted hold USA standardized 18" x 26" sheet pans (17⅞" x 25⅞" actual). We are not responsible for pans that do not meet the industry standard, which may not fit our racks.



## Enclosed Display Cabinet

Model No.	Size W-H-D	Angle Spacing	Angle Runners	Ship Lbs.
98063	20 $\frac{7}{8}$ " x 68 $\frac{1}{4}$ " x 27 $\frac{5}{8}$ "	5"	10 pair	162

Four 5" plate type swivel casters.

Accommodates 18" x 26" & 13" x 18" pans and trays.

**Options:** Options may not be NSF Certified. Contact the factory.

"B", "CL(B)", "PB" — see page 71 for details.

- Provides an attractive display with high product visibility.
- Combines an "open" look with the protection of an enclosed cabinet.
- Lifetime Guarantee against rust and corrosion.



Vented Lexan Side Panels



Angle Guides With Stops



98063



**!** All sheet pan racks quoted hold USA standardized 18" x 26" sheet pans (17 $\frac{7}{8}$ " x 25 $\frac{7}{8}$ " actual). We are not responsible for pans that do not meet the industry standard, which may not fit our racks.

## Slant Display Rack

Model No.	Size W-H-D	Pan Capacity	Runner Spacing	Ship Lbs.
1137	28 $\frac{1}{2}$ " x 70" x 22"	7	8 $\frac{3}{4}$ "	32
1139	28 $\frac{1}{2}$ " x 77 $\frac{1}{4}$ " x 22"	9	7 $\frac{1}{2}$ "	38

Four 5" stem type swivel casters.

Designed to accommodate 18" x 26" pans.

**Options:** Options may not be NSF Certified. Contact the factory.

"CL(A)", "VB" — see page 71 for details.

- Provides an attractive display with high product visibility.
- All welded aluminum construction.
- Lifetime Guarantee against rust and corrosion.
- NSF Certified.



1139



**!** All sheet pan racks quoted hold USA standardized 18" x 26" sheet pans (17 $\frac{7}{8}$ " x 25 $\frac{7}{8}$ " actual). We are not responsible for pans that do not meet the industry standard, which may not fit our racks.

# Room Service Carts



96005  
shown with optional cover (#0350)



Removable Tray Top

## Room Service Delivery Cart

Model No.	Size W-H-D	Runner Spacing	Pan Capacity	Ship Lbs.
96005	36¾" x 42¾" x 23"	5"	12	80

Four 6" plate type casters; two swivel with brake, two rigid.

Accommodates 15" x 20" trays.

### Options:

**0350 Vinyl Staph-Check® Cover for #96005 - Not NSF Certified.**  
-green vinyl cover with velcro closure

- All-welded, aluminum construction is lightweight yet durable.
- Holds 15" x 20" trays with space on the bottom for bus trays.
- Optional cover helps protect contents.
- Equipped with vertical corner bumpers at the top, a full perimeter bumper at the bottom and a vertical pan stop.
- 6" plate type casters provide maneuverability.



96004  
shown with optional cover (#0351)



## Room Service Tray Return Cart

Model No.	Size W-H-D	Runner Spacing	Pan Capacity	Ship Lbs.
96004	23" x 59¼" x 31¼"	5"	20	51

Four 5" stem type swivel casters.

Accommodates 15" x 20" trays.

### Options:

"CL(A)", "E", "MD" — Casters Locks are unavailable with the MD Option  
see page 71 for details.

**0351 Vinyl Staph-Check® Cover for #96004 - Not NSF Certified.**  
- green vinyl cover with velcro closure

- All-welded, aluminum construction is lightweight yet durable.
- Holds 15" x 20" trays.
- Optional "staph check" vinyl cover helps protect contents.
- Equipped with vertical corner bumpers at the bottom as well as a vertical pan stop.

## ▶ Donut Display Rack

Model No.	Size W-H-D	Angle Spacing	Pan Capacity	Ship Lbs.
52711	20 7/16" x 47" x 26 1/2"	8 1/2"	4	110

Four 4" plate type casters; two swivel, two swivel with brake.

Accommodates 18" x 26" sheet pans.

Custom made for a national donut chain, this unit was designed to fit into a millwork cabinet. Unit is powder coated and has LED lights.

- LED Light Bars are discreetly mounted under each shelf.
  - Light wiring runs down back side of tube with leg uprights.
- Power supply is mounted inside the base.
- Removable stainless steel tray sits inside base for easy cleaning.
- Can be customized to meet your needs.
- Lifetime Guarantee against rust and corrosion.



LED Light Bars mounted under each shelf



52711



## ▶ Donut Screen Rack

Model No.	Size W-H-D	Screen Capacity	Screen Size	Ship Lbs.
NS621KD	26 3/4" x 69" x 26"	20	23" x 23"	52
NS947KD	27 3/4" x 69" x 26"	20	24" x 24"	54
93020KD	26 3/4" x 69" x 33"	20	23" x 33"	62

Four 5" stem type swivel casters.

All models are shipped knocked down.

**Options:** Options may not be NSF Certified. Contact the factory.

"CL(A)", "VB" -- see page 71 for details.

- Four, one inch welds per angle guide.
- Standard 3" runner spacing.
- Shipped "Knocked Down" for freight savings.
- Lifetime Guarantee against rust and corrosion.
- NSF Certified.



93020KD



# Specialty Racks



1215

## ► Mobile Fry Cart

Model No.	Size W-H-D	Basket Capacity	Ship Lbs.
1210	18" x 52½" x 27"	18	29
1215	24½" x 52½" x 27"	27	34

Four 3" plate type swivel casters.

Corner bumpers and removable drip pan are standard.

- Designed to hold fry baskets in or out of the freezer.
- Available in double or triple basket widths.
- All welded aluminum construction.
- Lifetime Guarantee against rust and corrosion.
- NSF Certified.



PM2448 • PM2460

## ► Pot & Pan Rack

Model No.	Size D-H-L	Number Of Tiers	Ship Lbs.
<b>Stationary Units</b>			
P2448	24" x 76" x 48"	4	59
P2460	24" x 76" x 60"	4	86
<b>Mobile Units - 5" stem type swivel casters with brake</b>			
PM2448	24" x 74" x 48"	4	68
PM2460	24" x 74" x 60"	4	97

All units shipped knocked down.



## ▶ Oven Rack

New Age Industrial manufactures Oven Racks for the following brands of Rotating Rack Ovens:

- Adamatic
- Gemini
- Revent
- Customer Racks Available, call factory for details.
- Baxter
- Lucks
- Baker's Aid
- Hobart

**Call New Age at 800-255-0104  
for catalog information and pricing.**

- The toughest Oven Racks on the market.
- Our quality exceeds any other stainless steel or aluminum rack made.
- **Racks accommodate 18" x 26" sheet pans.**
- Heavy duty, 4" diameter "Hi-Temp" wheel casters.
- Six, 3/4" welds per angle runner...The most in the industry.
- Heavy duty all welded aluminum construction.
- Lifetime Guarantee against rust and corrosion.



1801A



## ▶ Carrier Cart

Model No.	Size W-H-L	Shelf Size	# Of Shelves	Shelf Spacing	Ship Lbs.
95667	20 1/2" x 55" x 64"	20" x 60"	3	top = 17 1/2" bottom = 18 1/2"	175

Four 6" x 2" plate type casters; two swivel, two swivel with brake.

- Multipurpose cart for the storage and transport of food modules, boxes, pots & pans, wire baskets, and similar items.
- Heavy duty all welded construction.
- All three solid shelves have three edges turned up (sides & back), with the front edge turned down.
- Upper two shelves are slanted 1° toward the rear to facilitate drainage.
  - All shelves have drainage holes.
- Equipped with four heavy duty 6" x 2" plate type swivel casters, two with brakes.
- **Shelf clearance = 17 1/2" • Weight Capacity = 1800 lbs.**
- Lifetime Guarantee against rust and corrosion.



95667



# Stands



99738



99217



Retractable 16 GA Stainless Steel Pull-Out Shelf & Top Bracing



98000



Outrigger Channels

## ► Mixer Stand

Model No.	Size W-H-D	Ship Lbs.
99738	29" x 70" x 23"	63

Four 5" plate type swivel casters with brake.

**Options:** Options may not be NSF Certified. Contact the factory.

**Cord Wrap** - Add "CW" suffix to model #.

- Stainless steel top and undershelf.
- Removable aluminum accessory pole.

## ► Slicer Stand

Model No.	Size W-H-D	Runner Spacing	Pan Capacity	Ship Lbs.
99217	28 <sup>3</sup> / <sub>8</sub> " x 30" x 20"	3"	6	67

Four 5" plate type swivel casters with total locks.

**Options:** Options may not be NSF Certified. Contact the factory.

"B", "E", "MD", "PB", "PS" — See page 71 for details.

**Cord Wrap** - Add "CW" suffix to model #.

- Designed to hold equipment, transport trays, and with the retractable shelf, hold pans while slicing.
- Accommodates 18" x 26" sheet pans.
- Four, one inch welds per angle guide.

## ► Slicer/Mixer Stand

Model No.	Size W-H-D	Runner Spacing	Pan Capacity	Ship Lbs.
98000	23 <sup>1</sup> / <sub>4</sub> " x 31 <sup>1</sup> / <sub>4</sub> " x 26"	1 <sup>1</sup> / <sub>2</sub> "	12	44
98001	23 <sup>1</sup> / <sub>4</sub> " x 37" x 26"	1 <sup>1</sup> / <sub>2</sub> "	16	61
98179	23 <sup>1</sup> / <sub>4</sub> " x 37" x 26"	3"	8	59

Four 5" plate type swivel casters with brake.

Vertical Corner Bumpers (4) are standard.

Designed to accommodate 13" x 18", 14" x 18" and 18" x 26" pans.

**Note:** Models #98000 & #98001 hold pans by the lip.

**Options:** Options may not be NSF Certified. Contact the factory.

"B", "E", "MD", "PB", "PS" — See page 71 for details.

**Cord Wrap** - Add "CW" suffix to model #.

# Pizza Pan Racks

## ► Universal Pizza Pan Rack

Model No.	Size W-H-D	Pan Size	Pan Clearance	Pan Capacity	Ship Lbs.
<b>Single-Wide • Single-Deep</b> - Ships Knocked Down					
97720	18½" x 72" x 16¾"	12" to 16"	2¾"	20	37
97722	20¾" x 72" x 16¾"	10" to 18"	2¾"	20	47
99309	20¾" x 72" x 16¾"	14" to 18"	2¾"	20	37
99456	<b>Vinyl Cover For Above Units • White With Two Zippers</b>				6
<b>Single-Wide • Double-Deep</b> - Ships Knocked Down					
97721	18½" x 72" x 32"	12" to 16"	2¾"	40	60
99310	20¾" x 72" x 32"	14" to 18"	2¾"	40	62
99457	<b>Vinyl Cover For Above Units • White With 4 Zippers</b>				6

Four 5" stem type swivel casters.

**Options:** Options may not be NSF Certified. Contact the factory.

"CL(A)", "VB" — See page 71 for details.

TABLE TOP UNIT					
99970	12" x 24½" x 13"	10" to 18"	1 ¾"	8	9

- Unique pan guide design accommodates various pan sizes.
- Optional vinyl covers for full-size units have a viewing window.



99970



97720



## ► Pizza Pan Rack

Model No.	Size W-H-D	Pan Capacity	Description	Runner Spacing	Ship Lbs.
NS590A	Adj. x 34¾" x 13¾"	13	1 Wide / 1 High	2"	28
NS599A	Adj. x 62½" x 13¾"	26	1 Wide / 2 High	2"	44
NS603A	Adj. x 62½" x 13¾"	52	2 Wide / 2 High	2"	70
NS596A	Adj. x 62½" x 13¾"	78	3 Wide / 2 High	2"	104
NS600A	Adj. x 34¾" x 13¾"	26	2 Wide / 1 High	2"	44

Four 5" stem type swivel casters.

Adjustable widths in 1" increments to hold 10" through and including 16" pans.

Width inside uprights = 10½" Minimum • 16½" Maximum

- Each rack is adjustable to accommodate a 10" to 16" pizza pan.
- Units ship knocked down for freight savings.



NS596A



NS599A



## ► Wall Mount Pan Racks

Model No.	Size W-H-D	Runner Spacing	Pan Capacity	Ship Lbs.
<b>Holds 13" x 18" (½-Size) Sheet Pans</b>				
50875	20¾" x 21" x 13"	3"	6	14
<b>Holds 18" x 26" (Full Size) Sheet Pans</b>				
98138	28¾" x 21" x 18"	3"	6	21

- Contact the factory for additional sizes and spacing.
- Lifetime Guarantee against rust and corrosion, superior strength and durability guaranteed.

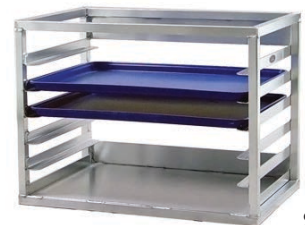

98138



# Tray Drying Racks



96704



## ► Correctional Duty Tray Drying Rack

Model No	Size ** W-H-L	Tray Levels	Guide Clearance	Tray Capacity	Ship Lbs.
96704	28½" x 64" x 58¼"	3	2.65"	120*	245
96705	28½" x 82" x 58¼"	4	2.65"	160*	239
96706	28½" x 64" x 69¼"	3	2.65"	144*	282
96707	28½" x 82" x 69¼"	4	2.65"	192*	343
96708	28½" x 64" x 63½"	3	1.4"	240*	290
96709	28½" x 82" x 63½"	4	1.4"	320*	318
96710	28½" x 64" x 75½"	3	1.4"	288*	318
96711	28½" x 82" x 75½"	4	1.4"	384*	395

Four 6" x 2" heavy duty plate type swivel casters with **tamper proof fasteners**.

\* Note: Tray Capacity is based on two, compartmented or insulated trays per slot.

\*\* Height varies, based on tray size, confirm with factory when ordering.  
Above height is based on a 16" tray.

**Options:** Options may not be NSF Certified. Contact the factory.

"CL(C)", "PB", "VB" — see page 71 for details.

**Note:** The bottom drainage channel is removed when perimeter and corner bumpers are used.

**!** These Tray Drying Racks are built-to-order and cannot be returned.

## ► Tray Drying Racks - Adjustable

Model No	Size W-H-L	Tray Levels	Guide Clearance	Ship Lbs.
95413	28" x 50½" x 63¾"	2	1.4"	172
96090	28" x 50½" x 59"	2	2.65"	159
95333	28" x 74½" x 63¾"	3	1.4"	234
96087	28" x 74½" x 59"	3	2.65"	219

Four 5" plate type swivel casters.

All units shipped knocked down.

**Options:** Options may not be NSF Certified. Contact the factory.

"CL(B)" — see page 71 for details.

- Shipped "Knocked Down" for freight savings.
- Tray capacity depends on style and size of tray.
  - Model #95413 & #95333 will hold (40) 18" x 26" trays per level (shelf), and #96090 & #96087 will hold (20) 18" x 26" trays per level (shelf).
- Heavy duty tray guides are .090" thick and are ideally spaced on 1½" and 2¾" centers.
  - Actual clearance: 1½" spacing = 1.4" • 2¾" spacing = 2.65"
- Heavy duty aluminum construction.
- Lifetime Guarantee against rust and corrosion.



95413





## ► Extreme Duty Utility Cart

Model No	Size W-H-L	Shelf Size	Shelf Spacing	Ship Lbs.
97177	22" x 41" x 37"	21¾" x 33⅝"	27"	66
97178	22" x 41" x 54"	21¾" x 50⅝"	27"	82
97179	29" x 41" x 37"	28¾" x 33⅝"	27"	72
97180	29" x 41" x 54"	28¾" x 50⅝"	27"	142

Four 6" plate type casters; two swivel, two rigid.

**Options:** Options may not be NSF Certified. Contact the factory.

"B", "CL(C)", "PB", "PP(A)", "VB" — see page 71 for details.

- Two-Tier units ideal for use in coolers, freezers, and dry storage.
- Transport heavy loads up to 1500 lbs. per shelf  
- 2000 lbs. Rolling Capacity -
- Heavy Duty 6" platform type casters.
- All welded, heavy duty aluminum construction.
- Lifetime Guarantee against rust and corrosion.



97180



## ► Correctional Duty Utility Cart

Model No.	Size W-H-L	Shelf Size	Shelf Spacing	Weight Capacity	Ship Lbs.
97769	18½" x 39" x 32½"	18½" x 28¾"	14½"	550 lbs.	42

Four 5" plate type casters; two swivel, two rigid. Attached with tamper proof fasteners.

**Three tier solid shelf unit:** each shelf with three sides up 1 ¼" and one side down 1 ¼".

**Options:** Options may not be NSF Certified. Contact the factory.

"B", "CL(B)", "VB" — see page 71 for details.

- Ideal three shelf unit for various tasks such as serving, bussing and general utility.
- Strength and durability of stainless steel at much less the cost.
- Lifetime Guarantee against rust and corrosion.



97769



# Queen Marys



1455



## ▶ Queen Mary - Aluminum

Model No.	Size D-H-L	Weight Capacity	Number Of Shelves	Shelf Spacing	Ship Lbs.
1450	29" x 66 3/4" x 62"	3000 lbs.	5	12"	186
1451	29" x 66 3/4" x 75"	2500 lbs.	5	12"	210
1452	29" x 66 3/4" x 62"	2500 lbs.	4	16 1/2"	174
1455	29" x 66 3/4" x 62"	3000 lbs.	6	9 1/4"	205

Four 8" plate type casters; two swivel, two rigid.

**Each Unit Is Equipped With A Full Perimeter Bumper.**

**Options:** Options may not be NSF Certified. Contact the factory.

"CL(E)"— see page 71 for details.

**Towing Options Available** — Call For Pricing

- Built for transporting BIG loads for banquets, catering, and bussing.
- Smooth radius handle and uprights.
- Solid shelves with marine edges add strength and contain spills.
- Standard perimeter bumper protects surfaces.
- Durable, all welded aluminum construction with 8" x 2" casters (standard).
- Model #1451 accepts 23" wide oval trays — 3 wide per shelf.
- Lifetime Guarantee against rust and corrosion.

## ▶ Queen Mary - Stainless

Model No.	Size D-H-L	Weight Capacity	Number Of Shelves	Shelf Spacing	Ship Lbs.
97942	29" x 66 3/4" x 65 1/2"	3000 lbs.	5	10 1/2"	355
98181	29" x 66 3/4" x 78 1/2"	2500 lbs.	5	10 1/2"	351
98182	29" x 66 3/4" x 65 1/2"	2500 lbs.	4	14 1/2"	322
98183	29" x 66 3/4" x 65 1/2"	3000 lbs.	6	8 1/4"	365

Four 8" plate type casters; two swivel, two rigid.

**Each Unit Is Equipped With A Full Perimeter Bumper.**

**Options:**

"CL(E)"— see page 71 for details.

**Towing Options Available** — Call For Pricing

- Built for transporting BIG loads for banquets, catering, and bussing.
- Durable, all welded aluminum frame with removable stainless steel shelf covers.
- Smooth radius handle and uprights.
- Standard perimeter bumper protects surfaces.
- Equipped with 8" x 2" casters (standard).
- Model #98181 accepts 23" wide oval trays — 3 wide per shelf.
- Lifetime Guarantee against rust and corrosion.



98182



## ▶ Scrap and Stack

Model Number	Size W-H-D	Ship Lbs.
53757	40" x 35" x 27¾"	65

Equipped with four, 5" plate type swivel casters, total lock brakes.

### Option: - Factory Installed Only

**Handle** - Add "H" suffix to model #.  
Unit with handle measures 38" H.

Built-in storage for empty steamtable and sheet pans makes this the go-to cart for quick and easy serving line cleanup.

- 12" x 12" waste chute with removable, easy to clean waste receptacle.
- **Top mounted pan rail holds two rows of stacked 12" x 20" steamtable pans.**
- **Angle slides mounted below holds stacked 18" x 26" sheet pans.**
- Removable receptacle for soiled spatulas, spoodles, and other serving utensils.
- 5" plate type swivel casters with total locks, provide easy maneuverability and stability.
- Lifetime Guarantee against rust and corrosion.



53757



53757H



## ▶ Share Cart

Model No.	Size D - H - L	Ship Lbs.
52861*	23 ¼" x 70" x 29 ⅞"	100

\* Must select color option.

Four 5" plate type casters, two swivel, two swivel with brake. All welded aluminum construction.

**Note:** Poly food boxes, custom signs and any other accessories are not included and must be purchased by end user.

### Factory Options: - Must select color option.

- **52918 - Cold Pan Shelf** -  
Hinged, drop-down shelf built to hold ½-size cold pan.
- **52919 - Computer/Tablet Shelf** -  
Hinged, drop down shelf for a computer/tablet.
- **Color options:**
  - **Red** - Add "RED" suffix to model #.
  - **Orange** - Add "ORANGE" suffix to model #.
  - **Yellow** - Add "YELLOW" suffix to model #.
  - **Green** - Add "GREEN" suffix to model #.
  - **Blue** - Add "BLUE" suffix to model #.
  - **Purple** - Add "PURPLE" suffix to model #.
  - **Black** - Add "BLACK" suffix to model #.

Initially designed for schools as a "Share Cart", this versatile cart can be seen in nursing homes, stadiums and club stores.

- Two locations for custom signs.
- Top shelf designed to hold two Coldmaster CoolCheck™ drop-ins. (pans included)
- Smooth radius push handle.
- Slanted second shelf for easy access and storage.
- Reinforced base shelf for miscellaneous storage.
- Lifetime Guarantee against rust and corrosion.



52861PURPLE



**No Ice Required!**

Comes with two, Coldmaster CoolCheck™ dop-ins.



52918BLUE



52919ORANGE



# Dollies



1171



NS926



1630



Removable Drip Tray

## ► Chill Dolly

Model No.	Size W-L	Description	Ship Lbs.
1171	22 1/2" x 21 1/2"	Single Stack	18
1172	22 1/2" x 42 1/2"	Double Stack	21
1174		Handle	8

Four 5" plate type casters; two swivel, two rigid.

Accepts Nestier®, Buckhorn® chillpac containers 20" x 24".

NS968	19" x 8" x 22 3/8"	Single Stack	16
-------	--------------------	--------------	----

Four 5" plate type swivel casters.

Accepts Nestier®, Buckhorn® chillpac containers 20" x 24".

**Options:** Options may not be NSF Certified. Contact the factory.

"CL(B)" - see page 71 for details.

- Heavy duty transport dollies...Ideal for cook-chill systems.
- Weight Capacity = 1000 lbs.
- Open base provides maximum air circulation.
- Lifetime Guarantee against rust and corrosion.
- NSF Certified.

## ► Crisping Basket Dolly

Model No.	Size W-H-L	Ship Lbs.
NS926	26 3/4" x 8" x 29 3/4"	18
<b>Crisping Baskets - Sold Separately. - Not NSF Certified.</b>		
0307	26" x 9" x 29"	8

**Aluminum Drag Hook- Not NSF Certified.**

1199	37 1/2" Long	1
------	--------------	---

Four 5" plate type casters; two swivel, two rigid.

#NS926 Does Not Include A Crisping Basket

**Options:** Options may not be NSF Certified. Contact the factory.

"CL(B)" - see page 71 for details.

- Superior strength and versatility for maximum loads
- Lifetime Guarantee against rust and corrosion.
- NSF Certified.

## ► Food Box Dolly

Model No.	Size W-H-L	Weight Capacity	Deck Height	Ship Lbs.
1630	24" x 36" x 33"	500 lbs.	12"	27
1631	24" x 36" x 33"	500 lbs.	16"	29
<b>Aluminum Drag Hook- Not NSF Certified.</b>				
1199	37 1/2" Long			1

Four 5" stem type swivel casters.

Removable Drip Tray Included.

**Options:** Options may not be NSF Certified. Contact the factory.

"CL(A)" — see page 71 for details.

- Superior strength and versatility for maximum loads.
- Lifetime Guarantee against rust and corrosion.
- NSF Certified.

## ► Mobile Dish Rack

Model No.	Size W-H-D	Tray Capacity	Runner Spacing	Ship Lbs.
<b>Standard Units</b>				
NS345	22" x 65" x 20 1/2"	8	7"	30
93037	22" x 69" x 20 1/2"	6	10"	30

Four 5" stem type swivel casters.

**Options:** Options may not be NSF Certified. Contact the factory.

"CL(A)", "PS", "VB" - see page 69 for details.

<b>Roll-In Unit</b>				
97142	22" x 64" x 20 1/2"	9	6"	45

Four 5" plate type swivel casters.

**Options:** Options may not be NSF Certified. Contact the factory.

"B", "CL(B)", "MD", "PB", "PS", "VB" - see page 71 for details.

All units accept 20" x 20" dish racks.

- These mobile racks easily move heavy loads.
- Eliminate wasted storage space.
- Lifetime Guarantee against rust and corrosion.
- NSF Certified.



NS345



97142



## ► Wall Mount Dish Rack Holder

Model No.	Size W-H-D	Tray Capacity	Runner Spacing	Ship Lbs.
53082	29" x 22 1/2" x 18"	6	4 1/2"	21
52924	61 1/2" x 22 1/2" x 18"	13	4 1/2"	38

Wall mount hardware is not included.

All units accept 20" x 20" dish racks.

- Designed to hold dish racks for storage and drying.
- Keeps racks easily accessible above sinks, tables and bussing stations.
- Eliminate wasted storage space.
- Can be customized to meet your requirements.
- Lifetime Guarantee against rust and corrosion.



52924



## ► Dish Rack Dolly

Model No.	Number of Stacks	Size W-H-D	Weight Capacity	Ship Lbs.
1176A	Single	20 3/8" x 9 3/8" x 22 3/8"	1000 lbs.	23
1179A	Handle			5.5

Four 5" plate type swivel casters.

All units accept 20" x 20" or smaller dish racks.

**Options:** Options may not be NSF Certified. Contact the factory.

"B", "CL(B)" - see page 71 for details.

- One piece solid pan construction with 1 1/2" lips up on all sides to contain spills.
- Optional handle available.
- Heavy duty aluminum construction with four 5" plate type casters.
- Lifetime Guarantee against rust and corrosion.
- NSF Certified.



1176A



1179A



# Dollies



95636



98716  
Accommodates Vollrath 80QT  
mixing bowl, model #79800.



99936



## ▶ Bowl Dolly

Model No.	Size W-H-D	Ring Diameter	Quart Size	Ship Lbs.
<b>Mixer Bowl Dolly/Stand - NSF Certified.</b>				
95636	26 <sup>3</sup> / <sub>4</sub> " x 30 <sup>3</sup> / <sub>8</sub> " x 26 <sup>3</sup> / <sub>4</sub> "	20 <sup>1</sup> / <sub>4</sub> " I.D.	80	34
98736	24 <sup>3</sup> / <sub>4</sub> " x 30 <sup>3</sup> / <sub>8</sub> " x 24 <sup>3</sup> / <sub>4</sub> "	18 <sup>1</sup> / <sub>4</sub> " I.D.	60	28
98737	29 <sup>3</sup> / <sub>8</sub> " x 30 <sup>3</sup> / <sub>8</sub> " x 29 <sup>3</sup> / <sub>8</sub> "	22 <sup>7</sup> / <sub>8</sub> " I.D.	140	29

Four 5" plate type casters; two swivel, two swivel with brake.

**Note: Unit Heights Do Not Include Bowls**

**Information is based on Hobart® mixing bowl sizes.**

**Options:** Options may not be NSF Certified. Contact the factory.

"B" - see page 71 for details.

**Mixing Bowl Dolly - Not NSF Certified.**

98716	30" x 30" x 30"	29 <sup>1</sup> / <sub>2</sub> " I.D.	80	24
-------	-----------------	---------------------------------------	----	----

Four 5" plate type swivel casters.

**Accommodates Vollrath 80QT mixing bowl, model #79800.**

**Options:** "B" - see page 71 for details.

## ▶ Mixer Bowl Transport Dolly

Model No.	Size W-H-D	Weight Capacity	Ship Lbs.
99936	14" x 7 <sup>9</sup> / <sub>16</sub> " x 14"	800 lbs.	15

Four 3" plate type swivel casters.

**Designed to hold an 40-120 quart bowl.**

- Designed to make rolling heavy mixing bowls in and out of place an easy task, this rust proof unit is ideal for the kitchen/prep room atmosphere.

## ▶ Mixing Bowl/Pan Rack Dolly

Model No.	Size W-H-D	Ring Diameter	Quart Size	Runner Spacing	Pan Capacity	Ship Lbs.
<b>Mixing Bowl Dolly - Not NSF Certified.</b>						
51949	22" x 31 <sup>5</sup> / <sub>8</sub> " x 26"	20.875" I.D.	30	4"	4	35

Four 5" plate type swivel casters with total lock.

**Accommodates 30QT mixing bowl and 18" x 26" sheet pans, not included.**



51949



- This Mixing Bowl Dolly is designed to hold a 30 quart mixing bowl, as well as full size standard sheet pans, at a working height; Minimizing uncomfortable working positions.
- Equipped with four 5" plate type swivel casters.
- Five-Year Guarantee against material defects and workmanship.
- Lifetime Guarantee against rust and corrosion.

## Pan Dollies

Model No.	Size W-H-D	Weight Capacity	Ship Lbs.
-----------	------------	-----------------	-----------

Angle Dolly Without Sides or Handle			
1192	18 <sup>7</sup> / <sub>8</sub> " x 7" x 27"	800 lbs.	18

Angle Dolly With Sides & Handle			
1193	21" x 33 <sup>1</sup> / <sub>2</sub> " x 28 <sup>1</sup> / <sub>2</sub> "	900 lbs.	25

Two Tier Angle Dolly With Sides & Handle			
1194	21" x 44 <sup>1</sup> / <sub>2</sub> " x 30"	900 lbs.	33

Four 5" plate type swivel casters.

Accommodates 18" x 26" sheet pans.

**Options:** Options may not be NSF Certified. Contact the factory. "CL(B)", "MD", "PP(A)" — see page 71 for details.

Oval Tray Dolly - Not NSF Certified.			
97055	26 <sup>3</sup> / <sub>8</sub> " x 33 <sup>3</sup> / <sub>4</sub> " x 30"	800 lbs.	36

Four 5" plate type casters; two swivel, two swivel with brake.

Accommodates up to 23<sup>1</sup>/<sub>2</sub>" x 29" oval trays.

**Options:** Options may not be NSF Certified. Contact the factory. "CL(B)" - see page 71 for details.

**Steamtable Pan Dolly - Not NSF Certified.**

4-Bay			
98998	30" x 48" x 44"	1000 lbs.	69

2-Bay			
98195	30" x 64" x 22"	1000 lbs.	46

Four 5" plate type swivel casters.

Accommodates up to 12" x 20" steam table pans.

**Options:** Options may not be NSF Certified. Contact the factory. "CL(B)" - see page 71 for details.

**Aluminum Drag Hook- Not NSF Certified.**

1199	37 <sup>1</sup> / <sub>2</sub> " Long		1
------	---------------------------------------	--	---



1193 • 1194 • 1192



97055



98195



98998



## Bulk Sheet Pan Dolly

Model No.	Size W-H-D	Pan Capacity	Ship Lbs.
-----------	------------	--------------	-----------

50112	27 <sup>3</sup> / <sub>4</sub> " x 73" x 28 <sup>1</sup> / <sub>2</sub> "	140	68
-------	---	-----	----

Four 8" plate type swivel casters.

Accommodates 18" x 26" sheet pans.

- Ideal for hotel, casino, hospital and correctional facilities.
- This unit will store and transport up to 140 sheet pans.
  - Designed to hold sheet pans at a backward angle to keep the stack from tipping forward outside of the frame.
- Can be customized to meet your specific needs.
- Lifetime Guarantee against rust and corrosion.



50112



## Bread Pan Dolly

Model No.	Size W-H-D	Weight Capacity	Ship Lbs.
-----------	------------	-----------------	-----------

Angle Dolly - Holds 5 strap 1lb. loaf pans (9 <sup>23</sup> / <sub>32</sub> " x 26")			
93189	21 <sup>7</sup> / <sub>8</sub> " x 6" x 28 <sup>1</sup> / <sub>8</sub> "	800 lbs.	17

Four 3" plate type swivel casters.

Universal Bread Pan Dolly			
95219	26 <sup>3</sup> / <sub>4</sub> " x 9" x 30 <sup>3</sup> / <sub>8</sub> "	800 lbs.	24

Four 5" plate type swivel casters.

**Options:** Options may not be NSF Certified. Contact the factory.

"CL(B)" - see page 71 for details. \*\*\*Model #95219 Only\*\*\*

**Aluminum Drag Hook- Not NSF Certified.**

1199	37 <sup>1</sup> / <sub>2</sub> " Long		1
------	---------------------------------------	--	---



93189



# Dollies



1622 NSF



1620

## ► Milk Crate Dolly

Model No.	Size W-H-D	Number Of Stacks	Crate Capacity	Ship Lbs.
1620	13¾" x 9" x 28¼"	2	8	19
1622	26¾" x 9" x 28¼"	4	16	22

Four 5" swivel type plate casters.

**Options:** Options may not be NSF Certified. Contact the factory.

"CL(B)" - see page 71 for details.

Aluminum Drag Hook- Not NSF Certified.			
1199	37½" Long		1

- Accommodates 13" x 13" Milk Crates.
- Superior strength and versatility for maximum loads.
- Lifetime Guarantee against rust and corrosion.



1182 NSF



1199

## ► Super Dolly

Model No.	Size W-H-D	Wheel Size	Weight Capacity	Ship Lbs.
1181	24" x 10" x 29½"	6"	2800 lbs.	30
1182	24" x 8" x 29½"	5"	1000 lbs.	18

Four plate type casters:

#1181 = two swivel, two rigid.

#1182 = two swivel, two rigid.

**Options:** Options may not be NSF Certified. Contact the factory.

"B", "CL(C)" (Model #1181), "CL(B)" (Model #1182) - see page 71.

Aluminum Drag Hook- Not NSF Certified.			
1199	37½" Long		1

## ► Chicken Dolly

Model No.	Size W-H-D	Weight Capacity	Ship Lbs.
1187	24" x 14" x 30¼"	500 lbs.	24

Replacement Drip Pan - Not NSF Certified			
1188			5

Aluminum Drag Hook - Not NSF Certified.			
1199	37½" Long		1

Four 5" stem type casters; two swivel, two with brake.

Comes equipped with drip pan.

- Specifically designed to stack iced or frozen foods.
- Compact dollies keep drips, spills and condensation to a minimum with a sturdy, removable drip pan.
- Lifetime Guarantee against rust and corrosion.
- NSF Certified.



1187





## ► Dough Dolly

Model No.	Size W-H-D	Wheel Size	Ship Lbs.
<b>Dough Dollies - Accepts 25<sup>3</sup>/<sub>4</sub>" x 2<sup>5</sup>/<sub>16</sub>" x 17<sup>13</sup>/<sub>16</sub>" trays or boxes.</b>			
1195	18" x 5 <sup>1</sup> / <sub>2</sub> " x 25 <sup>1</sup> / <sub>2</sub> "	3"	12
1196	18" x 8" x 25 <sup>1</sup> / <sub>2</sub> "	5"	14
Accepts Cambro® #DB18263CW & Toteline® trays Model #870008. <i>Toteline is a registered trademark of Molded Fiber Glass Tray Co.</i>			
<b>Pizza Dough Box Dolly- Accepts 18" x 26" dough boxes.</b>			
98040	20 1/2" x 7 1/4" x 27 1/4"	5"	18
<b>Aluminum Drag Hook- for Model #98040 Not NSF Certified.</b>			
1199	37 1/2" Long		1

### Casters:

#1195 = Four 3" plate type swivel casters.

#1196 & #98040 = Four 5" plate type swivel casters..

**Options:** Options may not be NSF Certified. Contact the factory.

"CL(B)" - see page 69 for details.



1195 • 1196



98040



## ► Utility/Bussing Cart

### Utility Bussing Cart

Model No.	Size W-H-D	Shelf Size	Shelf Spacing	Weight Capacity	Ship Lbs.
<b>3-Tier</b>					
NS745	18 1/2" x 39" x 32 1/2"	18 1/2" x 28 3/4"	13"	350 lbs.	35
1440	16 1/2" x 39" x 27 3/4"	16 1/2" x 24"	13"	350 lbs.	29

Four 5" stem type casters; two swivel, two swivel with brake.

Each shelf with three sides up 1/4" and one side down 1/4".

**Options:** Options may not be NSF Certified. Contact the factory.

"B", "MD", "VB" - see page 71 for details.

### Lug Dolly / Bussing Cart

Model No.	Size W-H-D	Weight Capacity	Ship Lbs.
99304	17 1/4" x 41 1/2" x 28"	150 lbs.	21

Four 5" stem type swivel casters.

**Not NSF Certified.**



NS745 NSF

99304



## ► Bus Tub Wall Shelf

Model No.	Size W-H-D	Number Of Tiers	Shelf Clearance	Ship Lbs.
98272	24" x 30" x 16"	2	12"	22
98301	36" x 30" x 16"	2	12"	24
98213	48" x 30" x 16"	2	12"	35
98142	60" x 30" x 16"	2	12"	45



98272



**Weight Capacity =** Determined by installation method and type of wall

# Can Racks



1227



1235

## ▶ 1/2-Size Can Rack

Model No.	Size W-H-D	Can Cap.		Top Style	Ship Lbs.
		#10	#5		
<b>1/2-Size - Can Rack (41" Tall)</b>					
1225	25" x 41" x 35"	72	96	Stainless	73
1226	25" x 41" x 35"	72	96	Aluminum	60
1226NT	25" x 41" x 35"	72	96	None	50
1227	25" x 41" x 35"	72	96	Poly	72
<b>Counter Height - Can Rack (35" Tall)</b>					
1235	25" x 35" x 35"	54	72	Stainless	68
1236	25" x 35" x 35"	54	72	Aluminum	57
1236NT	25" x 35" x 35"	54	72	None	44
1237	25" x 35" x 35"	54	72	Poly	69

Template for mounting Edlund No.1 Can Opener included.  
Four 5" plate type casters; two swivel with brake and two rigid.

**Options:** Options may not be NSF Certified. Contact the factory.

"PP(A)" — see page 71 for details.

1255 Solid Shelf Trays (3)

- Each unit boasts heavy gauge aluminum construction with the most welds in the industry, insuring years of strength and durability.
- Easily loaded/unloaded with one hand providing automatic stock rotation when loaded from the rear.
- Lifetime Guarantee against rust and corrosion.
- NSF Certified.

## ▶ Full Size Can Rack - Heavy Duty

Model No.	Size W-H-D	Can Capacity				Casters	Ship Lbs.
		#10	#5	#2½	#303		
1250*	25" x 71" x 35"	162	216	**	**	No	100
1250CK	25 ½" x 78" x 35"	162	216	**	**	Yes	125
1251*	23" x 66" x 35"	**	**	352	484	No	112
1254*	25" x 73" x 35"	**	288	**	**	No	102
1256*	25 ½" x 71" x 47"	216	297	**	**	No	130
1256CK	26" x 77 ¼" x 47"	216	297	**	**	Yes	137

\* Units without casters are equipped with adjustable feet.

\*\*\* Casters can not be retrofitted – Factory option only. \*\*\*

"CK" Units: Equipped with four 6" plate type casters; two swivel with brake, two rigid.

**Options:** Options may not be NSF Certified. Contact the factory.

"PP(A)" — see page 71 for details

1255 Solid Shelf Trays (3) - fits 35" deep Can Racks

1257 Solid Shelf Trays (3) - fits 47" deep Can Racks - **Not NSF Certified.**

Adjustable Feet - Replacement Available.

- Superior quality.
- Adjustable feet are standard with stationary units.
- Lifetime Guarantee against rust and corrosion.
- NSF Certified.



1250CK



## ► F.I.F.O. Can Rack - Heavy Duty

Model No.	Size W-H-D	Can Capacity #10	Ship Lbs.
<b>Stationary Unit</b>			
97294	27 1/8" x 79 1/2" x 42"	156	190
Adjustable Feet Standard.			
<b>Mobile Unit</b>			
97294CK	27 1/8" x 81 1/8" x 42"	156	208

Four 6" plate type casters; two swivel with brake, two rigid.

**Options:** Options may not be NSF Certified. Contact the factory.  
Adjustable Feet - Replacement Available.

- Automatically rotates stock — Loaded and retrieved from the front!
- Easily loaded from the front, no need to move it out from the wall.
- Holds (156) #10 cans within 8 square feet.



First Can In...  
First Can Out.



97294

## ► F.I.F.O. Can Rack - Standard

Model No.	Size W-H-D	Can Capacity #10	Ship Lbs.
<b>Stationary Unit</b>			
99381	26 5/8" x 78 1/4" x 42"	156	140

Adjustable Feet Standard.

**Options:** Options may not be NSF Certified. Contact the factory.  
Adjustable Feet - Replacement Available.

**\*\*Casters Can Not Be Placed On This Unit\*\***

- Automatically rotates stock — Loaded and retrieved from the front!
- Easily loaded from the front, no need to move it out from the wall.
- Holds (156) #10 cans within 8 square feet.



First Can In...  
First Can Out.



99381

## ► Full Size Can Rack - Standard

Model No.	Size W-H-D	Can Capacity #10	#5	Casters	Ship Lbs.
6259	25" x 71" x 35 1/4"	162	216	No	86

Adjustable Feet Standard.

**\*\*Casters Can Not Be Placed On This Unit\*\***

- Adjustable feet standard equipment.
- Store up to (162) #10 cans or (216) #5 cans in only six square feet of space.
- Provides automatic stock rotation when loaded from the rear.
- Inclined angle glides give you easy access to a large number of cans with one unit.



6259

# Dunnage Racks



1203

1203 with 1208 optional handle



6000 Series - Dunnage Racks



## ► Mobile Dunnage Rack

Model No.	Size D-H-L	Weight Capacity	Ship Lbs.
1201	20" x 8¼" x 25¾"	1000 lbs.	21
1211	20" x 8¼" x 31¾"	1000 lbs.	21
1202	20" x 8¼" x 37¾"	1000 lbs.	22
1200	20" x 8¼" x 43¾"	1000 lbs.	25
1203	20" x 8¼" x 49¾"	1000 lbs.	27
1212	20" x 8¼" x 61¾"	1000 lbs.	24
1208	<b>Handle for 20" Deep Units Above</b>		6
1213	24" x 8¼" x 25¾"	1000 lbs.	20
1214	24" x 8¼" x 31¾"	1000 lbs.	22
1204	24" x 8¼" x 37¾"	1000 lbs.	24
1205	24" x 8¼" x 43¾"	1000 lbs.	27
1206	24" x 8¼" x 49¾"	1000 lbs.	27
1207	24" x 8¼" x 61¾"	1000 lbs.	30
1174	<b>Handle for 24" Deep Units Above</b>		7.5

Four 5" plate type casters; two swivel with brake, two rigid.

**Options:** Options may not be NSF Certified. Contact the factory.

**Heavy Duty Casters** -Add "HD6" suffix to model #.

Four 6" plate type casters; two swivel with brake, two rigid.

**All Swivel Casters** -Add "SW" suffix to model #.

## ► Dunnage Rack Covers

Model No.	Size D-L	Ship Lbs.
<b>Anti-Slip Covers</b>		
51101	20" x 36"	11
51102	20" x 48"	14.5
51103	20" x 60"	18
<b>Solid Cover</b>		
95456	20" x 36"	4.5

Fits 2000 and 6000 Series Dunnage Racks with same D x L dimensions.

**Does NOT fit Lifetime Series Racks.**

Dunnage Rack sold separately.

- Anti-Slip, Raised tread, perforated top, has 3" O.C. Spacing - Disrupted elevation = 3/16".
- Removable sheet nests over Dunnage Rack frame.
- All Aluminum, Guaranteed Rust Free!

## ► Dunnage Rack - Standard

Model No.	Size D-H-L	Weight Capacity	Number Of Laterals	Ship Lbs.
6017	20" x 8" x 36"	2000 lbs.	4	8
6018	20" x 8" x 48"	2000 lbs.	4	10
6019	20" x 8" x 60"	1500 lbs.	4	13
6004	20" x 12" x 36"	2000 lbs.	4	9
6005	20" x 12" x 48"	2000 lbs.	4	11
6006	20" x 12" x 60"	1500 lbs.	4	14
6014	24" x 8" x 36"	2000 lbs.	5	9
6015	24" x 8" x 48"	2000 lbs.	5	11
6016	24" x 8" x 60"	1500 lbs.	5	14
6008	24" x 12" x 36"	2000 lbs.	5	10
6009	24" x 12" x 48"	2000 lbs.	5	12
6010	24" x 12" x 60"	1500 lbs.	5	15

## ► Dunnage Rack - Heavy Duty

Model No.	Size D-H-L	Weight Capacity	Number Of Laterals	Ship Lbs.
2001	18" x 8" x 36"	3000 lbs.	4	9
2002	18" x 8" x 48"	2500 lbs.	4	11
2003	18" x 8" x 60"	2000 lbs.	4	13
2029	18" x 12" x 24"	3200 lbs.	4	7
2020	18" x 12" x 36"	3000 lbs.	4	10
2021	18" x 12" x 48"	2500 lbs.	4	14
2022	18" x 12" x 60"	2000 lbs.	4	17
2017	20" x 8" x 36"	3000 lbs.	4	9
2018	20" x 8" x 48"	2500 lbs.	4	12
2019	20" x 8" x 60"	2000 lbs.	4	13
2051	20" x 12" x 24"	3000 lbs.	4	8
2052	20" x 12" x 30"	3000 lbs.	4	10
2004	20" x 12" x 36"	3000 lbs.	4	11
2054	20" x 12" x 42"	3000 lbs.	4	13
2005	20" x 12" x 48"	2500 lbs.	4	15
2006	20" x 12" x 60"	2000 lbs.	4	18
2031	24" x 8" x 24"	3000 lbs.	5	9
2014	24" x 8" x 36"	2500 lbs.	5	11
2015	24" x 8" x 48"	2500 lbs.	5	14
2016	24" x 8" x 60"	2000 lbs.	5	17
2032*	24" x 8" x 72"	4000 lbs.	5	20
2013	24" x 12" x 24"	2500 lbs.	5	9
2062	24" x 12" x 30"	2500 lbs.	5	11
2008	24" x 12" x 36"	2500 lbs.	5	15
2064	24" x 12" x 42"	2500 lbs.	5	15
2009	24" x 12" x 48"	2500 lbs.	5	21
2033	24" x 12" x 54"	2000 lbs.	5	17
2010	24" x 12" x 60"	2000 lbs.	5	24
2012*	24" x 12" x 72"	4000 lbs.	5	27
2026	30" x 12" x 36"	3000 lbs.	6	14
2027	30" x 12" x 48"	3000 lbs.	6	19
2028	30" x 12" x 60"	2500 lbs.	6	20
2007*	30" x 12" x 72"	4000 lbs.	6	27

\* Models have 6 legs.

**Options:** Options may not be NSF Certified. Contact the factory.

**Removable Aluminum Cover** - Call For Pricing.

**Custom Sizes Available** - Call For Pricing.

# Dunnage Racks



2000 Series - Dunnage Racks

- All feet are permanently sealed with welded aluminum caps... Not plastic.
- All welded aluminum racks keep product organized and off of the floor.
- Lifetime Guarantee against rust and corrosion.
- **E-Channel and Stacking units available** — Call factory for details.
- NSF Certified.



**The toughest Dunnage Rack on the market.**  
These all welded racks are "beefed up" to hold maximum weight capacities up to 5000 pounds.

## ★ Dunnage Rack

Model No.	Size W-H-D	Weight Capacity	Ship Lbs.
4004	20" x 12" x 36"	5000 lbs.	18
4005	20" x 12" x 48"	4000 lbs.	21
4006	20" x 12" x 60"	3400 lbs.	23
4008	24" x 12" x 36"	4000 lbs.	21
4009	24" x 12" x 48"	4000 lbs.	25
4010	24" x 12" x 60"	4000 lbs.	27
4027	30" x 12" x 48"	4000 lbs.	31
4065	36" x 12" x 48"	4000 lbs.	35



All LIFETIME SERIES products carry a LIFETIME Guarantee against rust and corrosion as well as a LIFETIME Guarantee against material defects and workmanship.



# Shelving



H.D. Series Three Shelf Unit



H.D. Series Three Shelf Unit  
w/ Optional "M6" Casters  
*Casters are factory installed only.*

- Ideal for **correctional facilities, supermarkets, hotels,** and institutions.
- Built to organize larger, heavier loads.
- New Age uses the heaviest aluminum extrusion for maximum life and strength.
- Mobile units available — Factory installed only.
- **All non-mobile units include adjustable feet.**
- Lifetime Guarantee against rust and corrosion, **superior** for refrigerated environments.
- E-Channel units available — Call factory for details.



## ▶ All Welded Shelving - H.D. Series

Model No.	Size D-H-L	Shelf Laterals	Ship Lbs.
<b>Two Shelf Unit - 34½" Shelf Clearance</b>			
1021	20" x 48" x 36"	4	53
1030	20" x 48" x 42"	4	56
1022	20" x 48" x 48"	4	60
1023	20" x 48" x 60"	4	65
1024	20" x 48" x 72"	4	71
1025	24" x 48" x 36"	5	56
1031	24" x 48" x 42"	5	60
1026	24" x 48" x 48"	5	63
1027	24" x 48" x 60"	5	69
1028	24" x 48" x 72"	5	74
<b>Three Shelf Unit - 22½" Shelf Clearance</b>			
1041	20" x 60" x 36"	4	56
1050	20" x 60" x 42"	4	64
1042	20" x 60" x 48"	4	67
1043	20" x 60" x 60"	4	78
1044	20" x 60" x 72"	4	87
1045	24" x 60" x 36"	5	61
1051	24" x 60" x 42"	5	75
1046	24" x 60" x 48"	5	75
1047	24" x 60" x 60"	5	82
1048	24" x 60" x 72"	5	93
<b>Four Shelf Unit - 18½" Shelf Clearance</b>			
1061	20" x 72" x 36"	4	65
1070	20" x 72" x 42"	4	80
1062	20" x 72" x 48"	4	83
1063	20" x 72" x 60"	4	91
1064	20" x 72" x 72"	4	111
1065	24" x 72" x 36"	5	71
1071	24" x 72" x 42"	5	81
1066	24" x 72" x 48"	5	85
1067	24" x 72" x 60"	5	102
1068	24" x 72" x 72"	5	117



### Mobile Units — *Factory Options Only*

#### 6" Plate type swivel casters

- Add "M6" suffix to model #.

#### 5" Plate type swivel casters

- Add "M5" suffix to model #.

**Options:** Options may not be NSF Certified. Contact the factory. "CL(B)", "CL(C)", "PP(A)" - see page 71 for details.



**Stationary Units | Weight Capacity = 1500 lbs. per shelf**

*Contact Factory for Mobile Unit Capacities.*

## ► All Welded Shelving - T-Bar Series

Model No.	Size D-H-L	Ship Lbs.
<b>Two Shelf Unit - 34¼" Shelf Clearance</b>		
1021TB	20" x 48" x 36"	55
1030TB	20" x 48" x 42"	57
1022TB	20" x 48" x 48"	67
1023TB	20" x 48" x 60"	73
1024TB	20" x 48" x 72"	77
1025TB	24" x 48" x 36"	56
1031TB	24" x 48" x 42"	63
1026TB	24" x 48" x 48"	69
1027TB	24" x 48" x 60"	76
1028TB	24" x 48" x 72"	80
<b>Three Shelf Unit - 22¼" Shelf Clearance</b>		
1041TB	20" x 60" x 36"	62
1050TB	20" x 60" x 42"	67
1042TB	20" x 60" x 48"	76
1043TB	20" x 60" x 60"	91
1044TB	20" x 60" x 72"	96
1045TB	24" x 60" x 36"	70
1051TB	24" x 60" x 42"	76
1046TB	24" x 60" x 48"	78
1047TB	24" x 60" x 60"	89
1048TB	24" x 60" x 72"	103
<b>Four Shelf Unit - 18¼" Shelf Clearance</b>		
1061TB	20" x 72" x 36"	78
1070TB	20" x 72" x 42"	83
1062TB	20" x 72" x 48"	88
1063TB	20" x 72" x 60"	103
1064TB	20" x 72" x 72"	119
1065TB	24" x 72" x 36"	90
1071TB	24" x 72" x 42"	92
1066TB	24" x 72" x 48"	97
1067TB	24" x 72" x 60"	112
1068TB	24" x 72" x 72"	127



T-Bar Series Three Shelf Unit  
w/ Optional "M5" Casters  
*Casters are factory installed only.*



T-Bar Series Four Shelf Unit



### Mobile Units — *Factory Options Only*

#### 6" Plate type swivel casters

- Add "M6" suffix to model #.

#### 5" Plate type swivel casters

- Add "M5" suffix to model #.

**Options:** Options may not be NSF Certified. Contact the factory.

"CL(B)", "CL(C)", "PP(A)" - see page 71 for details.



Closeup: Underside of T-Bar Shelf.

- **Ideal for correctional facilities.**
- Each unit has easy-to-clean flat surfaces that aid in the easy-on and easy-off of smaller product with the strength to hold heavy product.
- These all welded units keep product organized and off of the floor while providing adequate air flow.
- New Age "T"s are 2¼" wide and spaced 1¾" apart, giving our T-Bar shelves the most surface area.
- **All non-mobile units include adjustable feet.**
- Mobile units available — Factory installed only.
- Lifetime Guarantee against rust and corrosion, **superior** for refrigerated environments.



**Stationary Units | Weight Capacity = 1000 lbs. per shelf**

*Contact Factory for Mobile Unit Capacities.*

# Shelving



Complete Unit Shown With  
(3) HD Shelves  
(4) Posts (pg 43)



Adjust-A-Shelf — H.D. Series

- With weight capacities at one ton (2000#) per shelf, these units will hold almost anything!
- Built To Organize Large, Heavy Loads.
- Lifetime Guarantee against rust and corrosion, superior for refrigerated environments.
- E-Channel units available — Call factory for details.



**EASY** Order Complete Units with **ONE** model number.

Visit our Website  
NewAgeIndustrial.com  
for more information

## ► Adjust-A-Shelf Shelving | H.D. Series Heavy Duty

Model No.	Size D-L	Shelf Laterals	Ship Lbs.
1530HD	15" x 30"	3	6.2
1536HD	15" x 36"	3	7
1542HD	15" x 42"	3	7.5
1548HD	15" x 48"	3	8.8
1554HD	15" x 54"	3	9.5
1560HD	15" x 60"	3	10.3
1566HD	15" x 66"	3	11.6
1572HD	15" x 72"	3	12
1830HD	18" x 30"	4	7
1836HD	18" x 36"	4	8.7
1842HD	18" x 42"	4	9
1848HD	18" x 48"	4	11.5
1854HD	18" x 54"	4	11.8
1860HD	18" x 60"	4	12.3
1866HD	18" x 66"	4	13.8
1872HD	18" x 72"	4	14.8
2030HD	20" x 30"	4	8.2
2036HD	20" x 36"	4	8.7
2042HD	20" x 42"	4	9.6
2048HD	20" x 48"	4	12.8
2054HD	20" x 54"	4	13.4
2060HD	20" x 60"	4	13.9
2066HD	20" x 66"	4	14.9
2072HD	20" x 72"	4	16.4
2096HD*	20" x 96"	4	19
2430HD	24" x 30"	5	9
2436HD	24" x 36"	5	10
2442HD	24" x 42"	5	11.6
2448HD	24" x 48"	5	13.2
2454HD	24" x 54"	5	15
2460HD	24" x 60"	5	17.3
2466HD	24" x 66"	5	18
2472HD	24" x 72"	5	19.6
2496HD*	24" x 96"	5	24
3030HD	30" x 30"	6	10.5
3036HD	30" x 36"	6	12.4
3048HD	30" x 48"	6	16.2

Constructed of 1½" x 1¾" extruded aluminum tubing.

\* 96" Shelves Require 6 Posts.

**See Page 43 For Posts & Accessories.**

### Design Your Own Custom Unit

- All three series of "Adjust-A-Shelf" Shelving (the same length and width) are interchangeable.
- This allows you to custom make your own complete units with the type of shelving (H.D., T-Bar, Solid Brute) you need.
- Each unit assembles in minutes with only an allen wrench.



**Weight Capacity = 2000 lbs. per shelf**



## ▶ Adjust-A-Shelf Shelving | T-Bar Series Heavy Duty

Model No.	Size D-L	Ship Lbs.
1530TB	15" x 30"	6.25
1536TB	15" x 36"	7.4
1542TB	15" x 42"	8
1548TB	15" x 48"	10
1554TB	15" x 54"	10
1560TB	15" x 60"	11
1566TB	15" x 66"	12
1572TB	15" x 72"	13
1830TB	18" x 30"	7.5
1836TB	18" x 36"	8.8
1842TB	18" x 42"	9.5
1848TB	18" x 48"	11.5
1854TB	18" x 54"	12
1860TB	18" x 60"	13.6
1866TB	18" x 66"	14
1872TB	18" x 72"	16
2030TB	20" x 30"	8.4
2036TB	20" x 36"	9
2042TB	20" x 42"	10.2
2048TB	20" x 48"	12
2054TB	20" x 54"	13.3
2060TB	20" x 60"	14.2
2066TB	20" x 66"	15
2072TB	20" x 72"	16.8
2430TB	24" x 30"	9.5
2436TB	24" x 36"	10.5
2442TB	24" x 42"	12
2448TB	24" x 48"	14
2454TB	24" x 54"	15.5
2460TB	24" x 60"	17.5
2466TB	24" x 66"	18.6
2472TB	24" x 72"	20.6

See Page 43 For Posts & Accessories.



Closeup: Underside of T-Bar Shelf.

### Design Your Own Custom Unit

- All three series of "Adjust-A-Shelf" Shelving (the same length and width) are interchangeable.
- This allows you to custom make your own complete units with the type of shelving (H.D., T-Bar, Solid Brute) you need.
- Each unit assembles in minutes with only an allen wrench.



Weight Capacity = 1500 lbs. per shelf



Complete Unit Shown With  
(4) T-Bar Shelves  
(4) Posts (pg 43)  
(4) 5" Stem Type Casters (pg 43)



Adjust-A-Shelf — T-Bar Series

- Unique T-Bar construction allows for easy-on, easy-off of product for easy storage while providing maximum air circulation.
- Wide T-Bar and 1¾" space between "T"s gives more welds per "T" and more shelf surface.
- Lifetime Guarantee against rust and corrosion, superior for refrigerated environments.
- NSF Certified.

**EASY** Order Complete Units with **ONE** model number.

Visit our Website [NewAgeIndustrial.com](http://NewAgeIndustrial.com) for more information



# Shelving

## ► Adjust-A-Shelf Shelving | Solid Brute Series Heavy Duty



Complete Unit Shown With  
(5) Solid Brute Shelves  
(4) Posts (pg 43)



Adjust-A-Shelf - Solid Brute Series

- **Unique removable top permits easy clean-up while the reinforced under-bracing gives added support.**
- Lifetime Guarantee against rust and corrosion, **superior** for refrigerated environments.
- NSF Certified.



**EASY** Order Complete Units with **ONE** model number.

Visit our Website  
NewAgeIndustrial.com  
for more information

Model No.	Size D-L	Ship Lbs.
1530SB	15" x 30"	8
1536SB	15" x 36"	9.5
1542SB	15" x 42"	10.5
1548SB	15" x 48"	11.5
1554SB	15" x 54"	13
1560SB	15" x 60"	14
1830SB	18" x 30"	9
1836SB	18" x 36"	10
1842SB	18" x 42"	11.5
1848SB	18" x 48"	12.5
1854SB	18" x 54"	14
1860SB	18" x 60"	15
1872SB	18" x 72"	17.5
2030SB	20" x 30"	9
2036SB	20" x 36"	11
2042SB	20" x 42"	12.3
2048SB	20" x 48"	14
2054SB	20" x 54"	15.4
2060SB	20" x 60"	15.8
2066SB	20" x 66"	17.5
2072SB	20" x 72"	18
2430SB	24" x 30"	10.5
2436SB	24" x 36"	11.8
2442SB	24" x 42"	13.4
2448SB	24" x 48"	16.5
2454SB	24" x 54"	17
2460SB	24" x 60"	18.4
2466SB	24" x 66"	19.2
2472SB	24" x 72"	23.2

This solid shelf with reinforced bars provides a flat, smooth surface.

**See Page 43 For Posts & Accessories.**

### Design Your Own Custom Unit

- All three series of "Adjust-A-Shelf" Shelving (the same length and width) are interchangeable.
- This allows you to custom make your own complete units with the type of shelving (H.D., T-Bar, Solid Brute) you need.
- Each unit assembles in minutes with only an allen wrench.



**Weight Capacity = 800 lbs. per shelf**

## ▶ Adjustable H.D. Shelf - Standard

Model No.	Weight Capacity	Size W-L	Ship Lbs.
C1836HD	1100 lbs.	18" x 36"	7
C1848HD	1100 lbs.	18" x 48"	7.5
C1860HD	1100 lbs.	18" x 60"	9.2
C2436HD	1100 lbs.	24" x 36"	7.75
C2448HD	1100 lbs.	24" x 48"	10.1
C2460HD	1100 lbs.	24" x 60"	12.51
C2472HD	500 lbs.	24" x 72"	14.7

**See Page 43 For Posts & Accessories.**

- Built to accommodate heavier product and designed for use in all environments including freezers, coolers, as well as packaging and storage areas.
- Lifetime Guarantee against rust and corrosion.
- NSF Certified.



H.D. Style Shelf



## ▶ Adjustable T-Bar Shelf - Standard

Model No.	Weight Capacity	Size W-L	Ship Lbs.
C1836TB	900 lbs.	18" x 36"	7.4
C1848TB	900 lbs.	18" x 48"	8
C1860TB	900 lbs.	18" x 60"	10
C2436TB	900 lbs.	24" x 36"	8
C2448TB	900 lbs.	24" x 48"	10.6
C2460TB	900 lbs.	24" x 60"	13
C2472TB	500 lbs.	24" x 72"	16.3

**See Page 43 For Posts & Accessories.**

- Built to accommodate smaller item and heavier loads for use in all environments including freezers, coolers, as well as packaging and storage areas.
- Lifetime Guarantee against rust and corrosion.
- NSF Certified.



T-Bar Style Shelf



## ▶ Adjustable Solid Shelf - Standard

Model No.	Weight Capacity	Size D-L	Ship Lbs.
1530S	400 lbs.	15" x 30"	6.3
1536S	400 lbs.	15" x 36"	6.9
1542S	400 lbs.	15" x 42"	7.6
1548S	400 lbs.	15" x 48"	8.9
1830S	400 lbs.	18" x 30"	7.3
1836S	400 lbs.	18" x 36"	7.3
1842S	400 lbs.	18" x 42"	9.2
1848S	400 lbs.	18" x 48"	11
2030S	400 lbs.	20" x 30"	8.5
2036S	400 lbs.	20" x 36"	8.8
2042S	400 lbs.	20" x 42"	9.8
2048S	400 lbs.	20" x 48"	13

Economical solid shelf with double thick marine edge.

**Page 43 For Posts & Accessories.**

- Organizes Smaller, Lighter Product. Solid sheet design permits easy clean-up and minimizes the mess of "leaky" products.



Solid Style Shelf



**EASY** Order Complete Units with **ONE** model number.

Visit our Website [NewAgeIndustrial.com](http://NewAgeIndustrial.com) for more information



# Shelving

## ► Adjust-A-Shelf Shelving - Accessories



a. Floor Post Bracket



b. Wall Bracket

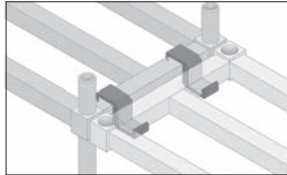

c. Pole Clip



d. U-Brace



e. Casters



f. Adjustable Foot



g. Handle/Desk



h. Handle



j. Document Tray



i. Trash Can

Model No.	Item Description	Ship Lbs.
<b>Brackets</b>		
a. NS496	Countertop/Floor Post Brackets	.5
b. NS885	Wall Brackets (pair): Secures Shelving to Wall	1
Attach shelving units to the floor or wall to meet the Seismic Requirements of most states.		
<b>Pole Clips *** H.D. &amp; T-Bar Shelves (pages 39-40) Only ***</b>		
c. PC432	Common Pole Clips (pair)	.25
Clip two units together, shelf to shelf, and eliminate two posts.		
<b>U-Braces</b>		
2036UB	U-Brace for 20" x 36" Shelves	4
2042UB	U-Brace for 20" x 42" Shelves	4.9
2048UB	U-Brace for 20" x 48" Shelves	5.5
2060UB	U-Brace for 20" x 60" Shelves	6.8
2436UB	U-Brace for 24" x 36" Shelves	5.1
2442UB	U-Brace for 24" x 42" Shelves	5.8
2448UB	U-Brace for 24" x 48" Shelves	6.6
2460UB	U-Brace for 24" x 60" Shelves	7.9
Adds extra support, keeping posts stable between large spans.		
<b>e. Casters</b>		
C440	5" Stem Type Casters with Brakes	2.5
Casters are heavy duty, easily installed and can be added in the field.		
<b>Adjustable Feet</b>		
f. 0116	Adjustable Feet	.5
Adjustable Feet are easily installed and can be added in the field.		
<b>g. Handle/Desk with Tray</b>		
50313	Fits 24"D Shelf Only	14
<b>1½" Tube Handle</b>		
50314	Fits 24"D Shelf Only	3
<b>i. Trash Can with Hanger</b>		
50315	Fits 24"D Shelf Only	13
<b>j. Document Tray</b>		
50316	4"D x 4"H x 16½"L • Fits 24"D Shelf Only	5

## Posts



Model No.	Length	Ship Lbs.
12P	12"	.6
34P	34"	1.7
48P	48"	2.5
54P	54"	3
60P	60"	3
68P	68"	3.6
72P	72"	3.9
76P	76"	4
84P	84"	4.1

Capped aluminum pipe (1½" o.d.).  
Marked in 2" increments.  
Weight Capacity = 1500 lbs. per post.



### Design Your Own Custom Unit

- All three series of "Adjust-A-Shelf" Shelving (the same length and width) are interchangeable.
- This allows you to custom make your own complete units with the type of shelving (H.D., T-Bar, Solid Brute) you need.
- Each unit assembles in minutes with only an allen wrench.

## Wall Shelves

Model No.	Size D-L	Weight Capacity	Number Of Hooks	Ship Lbs.
<b>a. T-Bar Wall Shelf / Pot Rack</b>				
1121PR	20" x 36"	700 lbs.	6	15
1122PR	20" x 48"	600 lbs.	7	21
1123PR	20" x 60"	500 lbs.	8	26

Adjustable pot rack hooks slide easily into place to fit your needs.  
Additional Pot Hooks Available.

Model No.	Size D-L	Weight Capacity	Ship Lbs.
<b>b. T-Bar Wall Shelves</b>			
1121	20" x 36"	700 lbs.	11
1122	20" x 48"	600 lbs.	14
1123	20" x 60"	500 lbs.	16
1124	24" x 60"	500 lbs.	26

Heavy duty shelf design for larger, heavier product.

<b>c. Slanted T-Bar Wall Shelves</b>			
97102	21" x 48"	600 lbs.	26

<b>d. Solid Wall Shelves- Regular 18 GA</b>			
NS675	12" x 24"	200 lbs.	5
1125	12" x 36"	150 lbs.	7
1126	12" x 48"	125 lbs.	8
1127	12" x 60"	100 lbs.	9

For lighter loads and smaller product, contains spills.

**Options: Extra Undershelf Brackets - Call Factory**

<b>d. Solid Wall Shelves - Heavy Duty 12 GA</b>			
NS675A	12" x 24"	300 lbs.	6
1125A	12" x 36"	300 lbs.	8
1126A	12" x 48"	225 lbs.	11
1127A	12" x 60"	150 lbs.	13
NS753	15" x 24"	300 lbs.	5
NS943	15" x 36"	300 lbs.	7
NS793	15" x 48"	225 lbs.	11
94249	15" x 60"	150 lbs.	12
95634	18" x 24"	300 lbs.	8
92093	18" x 36"	300 lbs.	10
92094	18" x 48"	225 lbs.	13
94136	18" x 60"	150 lbs.	15

Thick, 12 gauge for heavier loads. Performs like stainless steel.

**Options: Extra Undershelf Brackets - Call Factory**

<b>e. Microwave Shelf - Heavy Duty 12 GA</b>			
95634	18" x 24"	300 lbs.	8
95883	24" x 24"	300 lbs.	10

<b>f. Inverted Shelves - T-Bar - Not NSF Certified</b>			
97285	20" x 36"	500 lbs.	11
97286	20" x 48"	500 lbs.	14
97287	20" x 60"	500 lbs.	16

- Lifetime Guarantee against rust and corrosion.
- NSF Certified.



**Weight Capacity =** Determined by installation method and type of wall



# Shelving

## ► “Quick Change” Cantilever Shelving- Free-Standing



The above free-standing unit consists of the following:

- a. H.D. Shelf (2)
- b. T-Bar Shelf (2)
- c. Solid Shelf (2)
- d. Right Upright (1)
- e. Common Upright (1)
- f. Left Upright (1)
- g. Horizontal Brace (2 pair)  
*Note: One pair required per shelving section.*

**EASY** Order Complete Units with **ONE** model number.

Visit our Website [NewAgeIndustrial.com](http://NewAgeIndustrial.com) for more information

### Ordering Instructions

- Determine the number of shelving sections in the shelving run – Find type, number, and depth of shelves required per section. **a, b, c**
- Add a pair of horizontal braces per shelving section. **g**
- Shelving sections 3', 4', and 5' long require two uprights, one left and one right. **d, f**
- Run lengths over 5' require a left and right upright on the ends and a common upright between each section. (as shown in the picture above). **d, e, f**

### Note

- Shelving runs are described in one foot increments. The actual length of a run is an additional 2 3/4", i.e. a typical 7' run is actually 7' 2 3/4" (86 3/4") long.

Model No.	Size D-L	Weight Capacity	Ship Lbs.
<b>a. H.D. Bar Shelf</b>			
2501	18" x 36"	900 lbs.	6.5
2502	18" x 42"	900 lbs.	8.5
2503	18" x 48"	900 lbs.	9
2505	18" x 60"	900 lbs.	11.2
2511	24" x 36"	900 lbs.	8.3
2512	24" x 42"	900 lbs.	8.7
2513	24" x 48"	900 lbs.	9.2
2515	24" x 60"	900 lbs.	11

Full radius front edge.

<b>b. T-Bar Shelf</b>			
2521	18" x 36"	900 lbs.	9.5
2522	18" x 42"	900 lbs.	10.5
2523	18" x 48"	900 lbs.	11.8
2525	18" x 60"	900 lbs.	14.6
2531	24" x 36"	900 lbs.	11
2532	24" x 42"	900 lbs.	13.5
2533	24" x 48"	900 lbs.	14.5
2535	24" x 60"	900 lbs.	17

Ideal for smaller product as well as heavier loads.

<b>c. Solid Reinforced Shelf</b>			
2541	18" x 36"	700 lbs.	9.5
2542	18" x 42"	700 lbs.	10.5
2543	18" x 48"	700 lbs.	12
2545	18" x 60"	700 lbs.	14.6
2551	24" x 36"	700 lbs.	11
2552	24" x 42"	700 lbs.	12
2553	24" x 48"	700 lbs.	13
2555	24" x 60"	700 lbs.	19

For smaller products and spill control.

Model No.	Item Description	Ship Lbs.
<b>g. Horizontal Brace — Free-Standing Units Only</b>		
2581	36" Horizontal Brace (2)	3.9
2582	42" Horizontal Brace (2)	4.8
2583	48" Horizontal Brace (2)	5.8
2585	60" Horizontal Brace (2)	6.7

<b>Free-Standing Uprights — 72" in Height</b>		
f. 2561	21" Left Upright • 18" Shelves	12.52
d. 2563	21" Right Upright • 18" Shelves	12.5
e. 2565	21" Common Upright • 18" Shelves	14
f. 2571	27" Left Upright • 24" Shelves	13.5
d. 2573	27" Right Upright • 24" Shelves	13.5
e. 2575	27" Common Upright • 24" Shelves	14.5

Uprights have locking tabs spaced on 12" centers and an extended leg with adjustable foot.

Model No.	Item Description	Ship Lbs.
<b>Shelf Divider — Free-Standing &amp; Ceiling Mounted Units</b>		
h. 51233	60" Vertical Divider	14.5

Attaches securely to uprights – Sold Separately  
**Not NSF Certified.**





a.

**H.D. Bar Shelf • 900 lbs. Weight Capacity**



b.

**T-Bar Shelf • 900 lbs. Weight Capacity**



c.

**Solid Brute Shelf • 700 lbs. Weight Capacity**



**Ceiling Mounted Unit**

## Ordering Instructions

- Determine the number of shelving sections in the shelving run – Find type, number, and depth of shelves required per section.
- Horizontal braces are not needed.
- Shelving sections 3', 4', and 5' long require two uprights, one left and one right.
- Run lengths over 5' require a left and right upright on the ends and a common upright between each section. (as shown in the picture above).

## Note

- Upright height (length) is determined by ceiling height.
- Actual shelf depth from the wall to the front of the shelf is 3" more than the listed shelf depth.
- The actual shelving run length is found by adding 6½" to the sum of the shelf lengths in a shelving run — a typical 7' shelving run which uses a 36" shelf length and a 48" shelf length is actually 90½" long (7' 6½").



## ► “Quick Change II” Cantilever Shelving-Ceiling Mounted

Model No.	Item Description	Ship Lbs.
<b>Ceiling Mounted Uprights - Not NSF Certified.</b>		
95403	72" Left Upright	9
95404	72" Right Upright	9
95405	72" Common Upright	10.5
97753	84" Left Upright	10.5
97755	84" Right Upright	10.5
97754	84" Common Upright	11.4
95631	96" Left Upright	12.5
95632	96" Right Upright	12.5
95633	96" Common Upright	13
96617	108" Left Upright	14.5
96618	108" Right Upright	14.5
96619	108" Common Upright	15

Uprights have locking tabs spaced on 12" centers.

# Keg Shelving



NS933



51171



Keg Shelf Close-up



U-Brace / Wall Protectors

## ► Keg Stacker - Single-Deep

Model No.	Size D-H-L	½-Barrel Capacity	¼-Barrel Capacity	Number Of Shelves	Ship Lbs.
<b>Complete Units</b>					
31842TT7 †	18" x 76" x 42"	4	12	3	49
NS933	18" x 76" x 60"	6	18	3	71
NS475	18" x 76" x 72"	8	22	3	73
1288	18" x 76" x 80"	8	26	3	78
1289 *	20¾" x 76" x 93"	10	34	3	98
<b>Keg Shelves Only – Posts (see pg 43) **Customize Your Own Units**</b>					
94273	18" x 3" x 60"	3	9	1	14.4
95410 †	18" x 3" x 72"	4	11	1	16.5
94274	18" x 3" x 80"	4	13	1	21
94275 *	20¾" x 3" x 93"	5	17	1	23

### A. U-Brace / Wall Protectors - Not NSF Certified.

94029	18" x 2" x 60"				7.5
1872UB †	18" x 2" x 72"				5.4
94030	18" x 2" x 80"				9
94031 **	19¾" x 2" x 93"				10

\* Shelves Require Six Posts; This adds 2¾" to the overall depth.

\*\* Requires Six Posts; This adds 1¾" to overall depth

† Not NSF Certified.

## ► Keg Stacker - Double-Deep

Model No.	Size D-H-L	½-Barrel Cap.	¼-Barrel Cap.	Number Of Shelves	Ship Lbs.
<b>Complete Units</b>					
51169	34" x 84" x 42"	8	24	3	90
51170	34" x 84" x 54"	12	30	3	103.9
51171	34" x 84" x 60"	12	36	3	117
51172	34" x 84" x 72"	16	42	3	137
51173*	36¾" x 84" x 80"	16	48	3	214
51174*	36¾" x 84" x 93"	20	54	3	226
<b>Keg Shelves Only – Posts (see pg 43) **Customize Your Own Units**</b>					
51019	34" x 3" x 42"	4	12	1	27
51020	34" x 3" x 54"	6	15	1	35
51021	34" x 3" x 60"	6	18	1	42
51022	34" x 3" x 72"	8	21	1	50
51023*	36¾" x 3" x 80"	8	24	1	49
51024*	36¾" x 3" x 93"	10	27	1	57
<b>Top Shelves – Standard T-Bar ** Not For Kegs **</b>					
51025	34" x 2" x 42"	n/a	n/a	1	17
98951	34" x 2" x 54"	n/a	n/a	1	21.5
98953	34" x 2" x 60"	n/a	n/a	1	24
50723	34" x 2" x 72"	n/a	n/a	1	27
51026*	36¾" x 2" x 80"	n/a	n/a	1	31
51027*	36¾" x 2" x 93"	n/a	n/a	1	43

### A. U-Brace / Wall Protectors - Not NSF Certified.

51298	34" x 2" x 42"	n/a	n/a	n/a	6
51299	34" x 2" x 54"	n/a	n/a	n/a	7
51181	34" x 2" x 60"	n/a	n/a	n/a	8.5
51300	34" x 2" x 72"	n/a	n/a	n/a	9
51280**	35⅝" x 2" x 80"	n/a	n/a	n/a	10
51182**	35⅝" x 2" x 93"	n/a	n/a	n/a	11

\* Requires Six Posts; This adds 2¾" to the overall depth.

\*\* Requires Six Posts; This adds 1¾" to overall depth



# Keg Shelving

## ▶ Keg Stacker Accessories

Model No.	Size W-H-L	Ship Lbs.	Model No.	Size W-H-L	Ship Lbs.
<b>a. Solid Shelf Cover — Single-Deep Units Only</b>			<b>Solid Shelf Cover — Double-Deep Units Only</b>		
96492	18" x 2" x 42"	5	51328	34" x 2" x 42"	10
51268	18" x 2" x 54"	6	51270	34" x 2" x 54"	13
95435	18" x 2" x 60"	6	52352	34" x 2" x 60"	15
95549	18" x 2" x 72"	7	51271	34" x 2" x 72"	18
95436	18" x 2" x 80"	7	52354 *	34" x 2" x 80"	21
95437 *	18" x 2" x 93"	10	51305 *	34" x 2" x 93"	24

\* Comes in two separate pieces to accommodate center posts.

Model No.	Size W-H-L	Ship Lbs.
<b>b. EZ Panel Regulator Mount</b>		
51956	4" x 10" x 36" (fits 42" shelf)	9
52446	4" x 10" x 48" (fits 54" shelf)	12
52264	4" x 10" x 54" (fits 60" shelf)	13
52284	4" x 10" x 66" (fits 72" shelf)	14
52049	4" x 10" x 74" (fits 80" shelf)	17
52050	4" x 10" x 87" (fits 93" shelf)	17

Model No.	Size W-H-L	Ship Lbs.
<b>c. 1/2-Shelf — Double-Deep Units Only</b>		
51412	34" x 3" x 42"	20
52437	34" x 3" x 54"	23
51273	34" x 3" x 60"	25
52355	34" x 3" x 72"	28
51274	34" x 3" x 80"	32
51276*	35 3/8" x 3" x 93"	36

\* Requires Six Posts; This adds 1 3/8" to the overall depth.



## ▶ Keg Carrier

Model No.	Size W-H-L	Ship Lbs.
<b>Holds (5) 15.5 Gallon, Half-Barrel Kegs</b>		
51753	21 1/2" x 4 1/4" x 54 3/8"	8
<b>Holds (15), Sixth-Barrel (Craft) Kegs</b>		
52064	21 1/2" x 3 3/8" x 58 1/4"	13



51753



52064



52064 - Shown on BDT18568 (pg 63)



51753 - Shown on BDT18568 (pg 63)

## ▶ Keg Dolly

Model No.	Size W-H-L	Weight Capacity	Ship Lbs.
98037	17 1/4" x 5 1/4" x 17 1/4"	175 lbs.	13

Accommodates 1/4 and 1/2 Barrel Kegs up to 16 3/4" in diameter.  
Four 3" plate type swivel casters.

- Low profile helps reduce back injury.
- Lifetime Guarantee against rust and corrosion.



98037



**New Age Industrial Corporation, Inc.**  
Phone: 800.255.0104 or 785.877.5121 | Fax: 877.877.7687 or 785.877.2616

[www.NewAgeIndustrial.com](http://www.NewAgeIndustrial.com)

# Security



Standard Security Fence shown with "DSD" Option



Redesigned with "Easy Glide" Slides



Standard Security Fence - Left Hinge

Units Are Mounted To The Floor and Ceiling

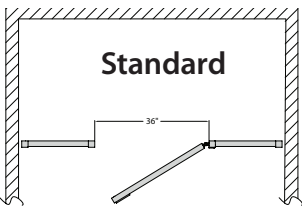

Standard

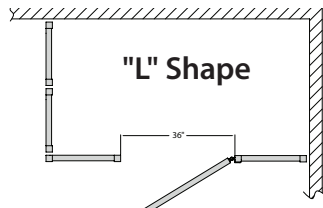

"L" Shape

Several Fence Configurations Are Available

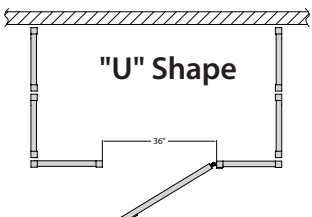

"U" Shape

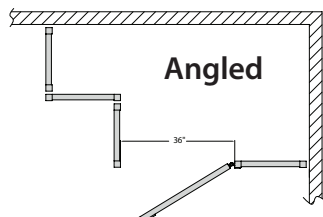

Angled

## Aluminum Security Fence

If the Security Fence falls within the **specified parameters**, with a **center door**:

**Opening Width = 68"-114" • Opening Height = 88"-110"**

**Safety Option:** Options may not be NSF Certified. Contact the factory.

**Inside Latch** - Add Suffix "XH"

*(Standard Door Only)*

Allows someone locked inside to escape without tools.

**Sliding Door Options:** Options may not be NSF Certified.

**Sliding Double Door** - Add Suffix "DSD"

Optional sliding double door for security fence, padlock holes in door handles for locking, approximate door opening 45" x 82".

**Sliding Single Door** - Add Suffix "SSD"

Optional sliding single door for security fence, padlock hole from door handle to frame for locking, approximate door opening 29" x 82".

Options may not be NSF Certified. Contact the factory.

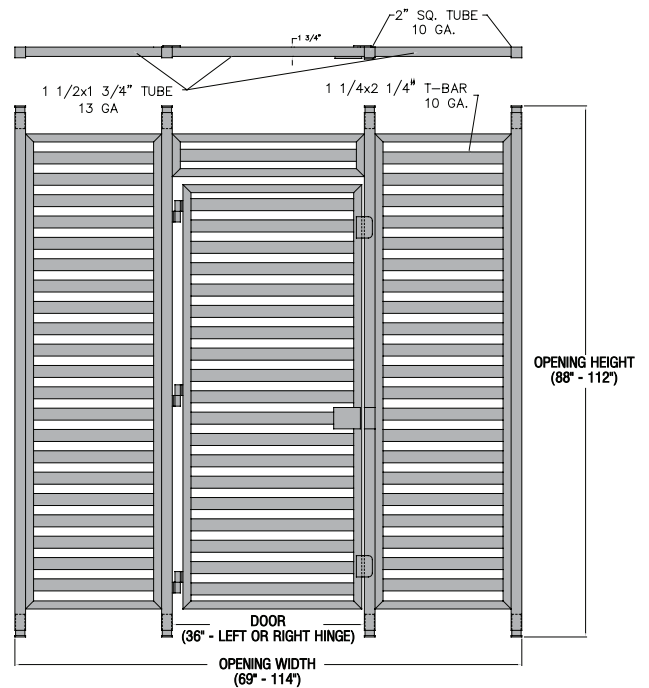

- Will not corrode like wire fencing.
- Additional Locking Options Available - *Contact the factory.*

**EACH FENCE NEEDS A CUSTOM QUOTE.** When requesting a Security Fence, we need the **WIDTH & HEIGHT of the opening** for the fence along with the **HINGE POSITION** (left or right). If there are special conditions such as a Ceiling Mounted Condenser or some other object that would require the fence to be modified, we need these dimensions to quote the fence.



**Note: Actual fence width is 2" less than the opening width. These Cages are built-to-order and cannot be returned.**

## ▶ Aluminum Security Cage

Model No.	Size W-H-D	Interior Shelves	Shelf Size	Clear Space	Ship Lbs.
<b>Mobile Security Cage</b>					
97621	49" x 71" x 26¾"	3	23½" x 45¾"	19"	170
Four 5" plate type swivel casters.					
<b>Stationary Security Cage</b>					
97846	48" x 72" x 24"	4	22" x 45"	14"	155
Equipped with four adjustable feet.					
<b>Solid Security Cage With Vents</b>					
98167	49¼" x 70½" x 25½"	3	24" x 45"	19"	190
Four 5" plate type swivel casters.					
<b>Solid Security Cage With Adjustable Shelves</b>					
99551	37¼" x 72¾" x 26"	3	22½" x 35"	Adj.	175
Four 5" plate type swivel casters.					

**Options:** Options may not be NSF Certified. Contact the factory.

**Prison Package** - Add "PP" suffix to model #

- Provides safe, lockable security of valuable and/or dangerous materials.
  - Ideal "emergency box" for schools
  - Use for chemical storage
- Equipped with double doors with a stainless steel hasp and replaceable stainless steel hinges.
- All welded aluminum construction.
- Lifetime Guarantee against rust and corrosion.

**!** These Cages are built-to-order and cannot be returned.



97621



97846



98167



99551



# Tables



Solid Poly Top



Stainless Steel Top  
With Backsplash



Solid Poly Top  
w/ Backsplash & Undershef



## ► Poly Top Tables

Model No.	Size D-H-L	Ship Lbs.	Model No.	Size D-H-L	Ship Lbs.	Model No.	Ship Lbs.
<b>Solid PolyTop -- No Backsplash</b>			<b>Poly Top With 6" Stainless Steel Backsplash</b>			<b>Undershef</b>	
24P36KD	24" x 35½" x 36"	50	24PBS36KD	24" x 35½" x 36"	60	24US36KD	8
24P48KD	24" x 35½" x 48"	59	24PBS48KD	24" x 35½" x 48"	68	24US48KD	11
24P60KD	24" x 35½" x 60"	73	24PBS60KD	24" x 35½" x 60"	73.5	24US60KD	14
24P72KD	24" x 35½" x 72"	86	24PBS72KD	24" x 35½" x 72"	101	24US72KD	17
24P84KD	24" x 35½" x 84"	99	24PBS84KD	24" x 35½" x 84"	106	24US84KD	19
24P96KD	24" x 35½" x 96"	106	24PBS96KD	24" x 35½" x 96"	111	24US96KD	22
30P36KD	30" x 35½" x 36"	55	30PBS36KD	30" x 35½" x 36"	60	30US36KD	10
30P48KD	30" x 35½" x 48"	71	30PBS48KD	30" x 35½" x 48"	85	30US48KD	13
30P60KD	30" x 35½" x 60"	80	30PBS60KD	30" x 35½" x 60"	97	30US60KD	17
30P72KD	30" x 35½" x 72"	100	30PBS72KD	30" x 35½" x 72"	108	30US72KD	20
30P84KD	30" x 35½" x 84"	104	30PBS84KD	30" x 35½" x 84"	120	30US84KD	23
30P96KD	30" x 35½" x 96"	115	30PBS96KD	30" x 35½" x 96"	132	30US96KD	27

## ► Stainless Steel Top Tables

Model No.	Size D-H-L	Ship Lbs.	Model No.	Size D-H-L	Ship Lbs.	Model No.	Ship Lbs.
<b>Solid Stainless Steel Top -- No Backsplash</b>			<b>Stainless Steel Top With 6" Backsplash</b>			<b>Undershef</b>	
24SS36KD	24" x 35½" x 36"	46	24SSB36KD	24" x 35½" x 36"	49	24US36KD	8
24SS48KD	24" x 35½" x 48"	59	24SSB48KD	24" x 35½" x 48"	61	24US48KD	11
24SS60KD	24" x 35½" x 60"	74	24SSB60KD	24" x 35½" x 60"	77	24US60KD	14
24SS72KD	24" x 35½" x 72"	81	24SSB72KD	24" x 35½" x 72"	88	24US72KD	17
24SS84KD	24" x 35½" x 84"	112	24SSB84KD	24" x 35½" x 84"	115	24US84KD	19
24SS96KD	24" x 35½" x 96"	116	24SSB96KD	24" x 35½" x 96"	119	24US96KD	22
30SS36KD	30" x 35½" x 36"	51	30SSB36KD	30" x 35½" x 36"	52	30US36KD	10
30SS48KD	30" x 35½" x 48"	63	30SSB48KD	30" x 35½" x 48"	65	30US48KD	13
30SS60KD	30" x 35½" x 60"	71	30SSB60KD	30" x 35½" x 60"	80	30US60KD	17
30SS72KD	30" x 35½" x 72"	87	30SSB72KD	30" x 35½" x 72"	95	30US72KD	20
30SS84KD	30" x 35½" x 84"	101	30SSB84KD	30" x 35½" x 84"	110	30US84KD	23
30SS96KD	30" x 35½" x 96"	114	30SSB96KD	30" x 35½" x 96"	125	30US96KD	27

## ▶ Table Accessories

Model No.	Item Description	Size	Ship Lbs.
<b>Table Accessories</b>			
1375	Paper Holder	12" x 5" x 31"	3
1376	Platter Holder	30" x 24"	17
1377	Drawer/Hardware	15" x 18"	10
1379	S.S. Backsplash 6" x 6"	36"	14
1380	S.S. Backsplash 6" x 6"	48"	16
1381	S.S. Backsplash 6" x 6"	60"	19
1382	S.S. Backsplash 6" x 6"	72"	22
1383	S.S. Backsplash 6" x 6"	84"	25
1384	S.S. Backsplash 6" x 6"	96"	28

#1376 Fits 30" deep tables only.

Not NSF Certified.

Casters Available - Factory Installed Only.



## ▶ Cantilever Overshelves

Model No.	Item Description	Ship Lbs.
99653	12" x 36" SS Shelf, Posts & Brackets	25
99654	12" x 36" SS Shelf	16
99821	12" x 48" SS Shelf, Posts & Brackets	34
99822	12" x 48" SS Shelf	22
99823	12" x 60" SS Shelf, Posts & Brackets	43
99824	12" x 60" SS Shelf	28
99825	12" x 72" SS Shelf, Posts & Brackets	51
99826	12" x 72" SS Shelf	37

Not NSF Certified.



## ▶ Boat Racks

Model No.	Size D-H-L	Ship Lbs.
<b>Table Mount Boat Racks</b>		
120T	15" x 21¼" x 36"	16
1371T	15" x 21¼" x 48"	24
1372T	15" x 21¼" x 60"	21
1373T	15" x 21¼" x 72"	22
1374T	15" x 21¼" x 96"	27
1375T	15" x 21¼" x 120"	30
<b>Wall Mount Boat Racks</b>		
120W	15" x 21¼" x 36"	11
1371W	15" x 21¼" x 48"	14
1372W	15" x 21¼" x 60"	18
1373W	15" x 21¼" x 72"	19
1374W	15" x 21¼" x 96"	22
1375W	15" x 21¼" x 120"	29
<b>Ceiling Mount Boat Racks — "L" Type</b>		
1373CL	15" x 21¼" x 72"	25
1374CL	15" x 21¼" x 96"	28
<b>Ceiling Mount Boat Racks — "T" Type</b>		
1373CT	29" x 21¼" x 72"	36
1374CT	29" x 21¼" x 96"	41

All Boat Racks Include Mounting Brackets.

Options: Options may not be NSF Certified. Contact the factory.

1378 Boat Rack Divider - Not NSF Certified

### Wall Mount Boat Rack

- Structural aluminum mesh creates back and base.
- Allows easy cleaning.



### Ceiling Mount Boat Rack - "L"

- Structural aluminum mesh with "L" type shelf, vertically adjustable telescoping mount.



### Ceiling Mount Boat Rack - "T"

- Structural aluminum mesh with "T" type shelf, vertically adjustable telescoping mount.
- Storage on front and back of unit.



# Accessories

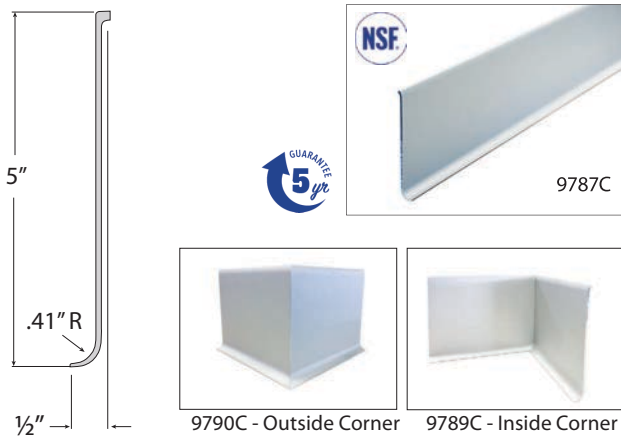

## ▶ Aluminum Cove Baseboard

Model No.	Length	Height	Ship Lbs.
<b>Cove Baseboard - NSF Certified</b>			
9787C	96"	5"	4.65
<b>Inside Corner - (2) Pieces - Not NSF Certified</b>			
9789C	5"	5"	1
<b>Outside Corner - (2) Pieces - Not NSF Certified</b>			
9790C	5"	5"	1

- Solid anodized aluminum keeps its good looks and cleans up with just soap and water.
- Use instead of quarry tile or vinyl.
- Due to its natural propensity to ward off rust and corrosion, this baseboard is perfect for any type of atmosphere.
- Easy to install.

## ▶ Aluminum Glove Box Holder

Model No.	Size W-L-D	Holds Boxes	Ship Lbs.
98144	5 5/16" x 9 3/4" x 3 1/16"	up to 5"W x 3 3/4"D	3

Not NSF Certified.

- Items traditionally manufactured in stainless steel but can be made from aluminum at a more economic price point.

## ▶ Corner Guards

Model No.	Length	Ship Lbs.
<b>2" x 2" Wings 90°</b>		
97873	36"	1.5
97874	48"	1.9
97875	60"	5
97876	72"	5.5
<b>3" x 3" Wings 90°</b>		
97877	36"	3.5
97878	48"	4
97879	60"	5.5
97880	72"	6

.080" Thick Aluminum Sheet.

Not NSF Certified.



## ▶ Equipment Stand - Heavy Duty

Model No.	Size W-H-D	Top Style	Ship Lbs.
24ESS29	24" x 24" x 29"	Stainless	31
24ESA29	24" x 24" x 29"	Aluminum	22.5

Units equipped with NSF Certified adjustable feet.

**Options:** Options may not be NSF Certified. Contact the factory.

**Aluminum Undershef** - Add "US" suffix to model #.

**Casters** - Add suffix "999" to model #.

- All swivel with brake. • Height with casters = 24".

\*\* Casters Are Factory Installed Only \*\*



98144



24ESS29999 | Stand with optional casters



# Equipment Stands

## ► Equipment Stand - Standard

Model No.	Size D-H-L	Ship Lbs.	Model No.	Size D-H-L	Ship Lbs.
<b>Stationary Units - Aluminum Top</b>			<b>Stationary Unit w/ Aluminum Top &amp; Undershelf</b>		
12436GS	24" x 24" x 36"	27.5	12436GSU	24" x 24" x 36"	37
12448GS	24" x 24" x 48"	32	12448GSU	24" x 24" x 48"	45
12460GS	24" x 24" x 60"	37	12460GSU	24" x 24" x 60"	51.5
12472GS	24" x 24" x 72"	45	12472GSU	24" x 24" x 72"	55
13036GS	30" x 24" x 36"	31	13036GSU	30" x 24" x 36"	43
13048GS	30" x 24" x 48"	37	13048GSC	30" x 24" x 48"	50
13060GS	30" x 24" x 60"	50	13060GSU	30" x 24" x 60"	62
13072GS	30" x 24" x 72"	55	13072GSU	30" x 24" x 72"	66



13036GSCUSR

Model No.	Size D-H-L	Ship Lbs.	Model No.	Size D-H-L	Ship Lbs.
<b>Mobile Unit - Aluminum Top</b>			<b>Mobile Unit w/ Aluminum Top &amp; Undershelf</b>		
12436GSC	24" x 24" x 36"	38	12436GSCU	24" x 24" x 36"	44
12448GSC	24" x 24" x 48"	40	12448GSCU	24" x 24" x 48"	51
12460GSC	24" x 24" x 60"	47	12460GSCU	24" x 24" x 60"	57
12472GSC	24" x 24" x 72"	52	12472GSCU	24" x 24" x 72"	70
13036GSC	30" x 24" x 36"	41	13036GSCU	30" x 24" x 36"	51
13048GSC	30" x 24" x 48"	50	13048GSCU	30" x 24" x 48"	57
13060GSC	30" x 24" x 60"	52	13060GSCU	30" x 24" x 60"	71
13072GSC	30" x 24" x 72"	59	13072GSCU	30" x 24" x 72"	82



12448GSC

Four 5" stem type casters.  
Weight Capacity = 1000 lbs.

**Options:** Options may not be NSF Certified. Contact the factory.

**Sandwich Rail** - Add "SR" suffix to model #.

- 36" long
- 48" long
- 60" long
- 72" long

**Note:** Must use same length sandwich rail as Equipment Stand.

Other options available - Contact factory for quote.



21524ES24P • 21524ES24PC

## ► Modular Aluminum Equipment Stand

Model No.	Size D-H-L	Ship Lbs.	Model No.	Size D-H-L	Ship Lbs.	Model No.	Size D-H-L	Ship Lbs.
21524ES24P	15" x 24" x 24"	15	21524ES30P	15" x 30" x 24"	17	21524ES36P	15" x 36" x 24"	17
21530ES24P	15" x 24" x 30"	22	21530ES30P	15" x 30" x 30"	19	21530ES36P	15" x 36" x 30"	20
21536ES24P	15" x 24" x 36"	19	21536ES30P	15" x 30" x 36"	20	21536ES36P	15" x 36" x 36"	21
21542ES24P	15" x 24" x 42"	20	21542ES30P	15" x 30" x 42"	21	21542ES36P	15" x 36" x 42"	22.5
21548ES24P	15" x 24" x 48"	23	21548ES30P	15" x 30" x 48"	24	21548ES36P	15" x 36" x 48"	25
21824ES24P	18" x 24" x 24"	17	21824ES30P	18" x 30" x 24"	18	21824ES36P	18" x 36" x 24"	19
21830ES24P	18" x 24" x 30"	19.5	21830ES30P	18" x 30" x 30"	20.5	21830ES36P	18" x 36" x 30"	22
21836ES24P	18" x 24" x 36"	22	21836ES30P	18" x 30" x 36"	22.5	21836ES36P	18" x 36" x 36"	24.
21842ES24P	18" x 24" x 42"	23.5	21842ES30P	18" x 30" x 42"	24.5	21842ES36P	18" x 36" x 42"	25.5
21848ES24P	18" x 24" x 48"	27.5	21848ES30P	18" x 30" x 48"	28.5	21848ES36P	18" x 36" x 48"	29.5
22024ES24P	20" x 24" x 24"	20	22024ES30P	20" x 30" x 24"	21	22024ES36P	20" x 36" x 24"	22
22030ES24P	20" x 24" x 30"	22	22030ES30P	20" x 30" x 30"	23	22030ES36P	20" x 36" x 30"	24
22036ES24P	20" x 24" x 36"	25.5	22036ES30P	20" x 30" x 36"	24.5	22036ES36P	20" x 36" x 36"	25
22042ES24P	20" x 24" x 42"	25.5	22042ES30P	20" x 30" x 42"	26	22042ES36P	20" x 36" x 42"	27
22048ES24P	20" x 24" x 48"	31	22048ES30P	20" x 30" x 48"	28.5	22048ES36P	20" x 36" x 48"	33

Not NSF Certified.

**Options:**

**Castors (4):** Add "C" suffix to model #.

- Stem type swivel casters with brake.

**Note:** This option adds 6" to the overall height of the unit.



**New Age Industrial Corporation, Inc.**

Phone: 800.255.0104 or 785.877.5121 | Fax: 877.877.7687 or 785.877.2616

[www.NewAgeIndustrial.com](http://www.NewAgeIndustrial.com)

# Carts & Trucks

## ► Produce/Stocking Cart

Model No	Size W-H-L	Weight Capacity	Number Of Casters	Top Shelf Height	Shelf Spacing	Ship Lbs.
<b>Solid Top Shelf • T-Bar Bottom Shelf</b>						
1415	19" x 30" x 41"	800 lbs.	4	30"	20"	43
<b>Solid Top Shelf • T-Bar Bottom Shelf w/ Handle</b>						
1416	19" x 42" x 48"	800 lbs.	4	30"	20"	46
<b>T-Bar Top &amp; Bottom Shelf w/ Handle</b>						
1420	19" x 42" x 48"	1000 lbs.	4	30"	20"	45
<b>Solid Top &amp; Bottom Shelf w/ Handle</b>						
1490	19" x 39" x 48"	800 lbs.	6	30"	20"	55
<b>Solid Top &amp; Bottom Shelf w/ Handle - "Floral Cart" - Not NSF Certified</b>						
NS765	18 <sup>5</sup> / <sub>8</sub> " x 32" x 45"	500 lbs.	4	32"	22 <sup>1</sup> / <sub>2</sub> "	43

Model #1415, #1416 & #1420: Four 5" plate type casters; two swivel, two rigid.

Model #1490: Six 5" plate type casters; four swivel, two rigid.

Model #NS765: Four 5" plate type swivel casters.

**Options: \*\*\* FACTORY INSTALLED ONLY\*\*\*** Options may not be NSF Certified. Contact the factory. "CL(B)", "PB" — See page 71 for details.

- These all welded units provide maximum strength and durability.
- Raised marine edge on solid shelves contains spills.
- T-Bar type shelves provide air circulation.
- Lifetime Guarantee against rust and corrosion.
- NSF Certified. (Excluding model #NS765)



1415



1416



1490



1420



NS765



Spill Containing Shelves





## ► Heavy Duty Stock Truck

Model No	Size W-H-L	Weight Capacity	Top Shelf Type	Top Shelf Height	Shelf Spacing	Ship Lbs.
NS557	21" x 44" x 59½"	3000 lbs.	Bar	30"	18"	62
<b>Unit With Solid Aluminum Top</b>						
NS557A	21" x 44" x 59½"	3000 lbs.	Solid	30"	18"	65

Two tier unit with handle.

Four 6" x 2" plate type casters; two swivel with brake, two rigid.

**Options:** Options may not be NSF Certified. Contact the factory.

"B", "PB", "VB" - See page 71 for details.

- For use in any application that requires maximum strength and durability.
- All welded aluminum construction with four, 6" x 2" plate type casters.
- 3,000 lbs. Weight capacity.
- Lifetime Guarantee against rust and corrosion.
- NSF Certified.



NS557



## ► Tubular Deck Cart

Model No	Size W-H-L	Weight Capacity	Top Shelf Height	Shelf Spacing	Ship Lbs.
95661	19" x 42" x 45"	700 lbs.	30"	20⅝"	40

Four 5" plate type casters; two swivel, two rigid.

**Options:** Options may not be NSF Certified. Contact the factory.

"CL(B)" - See page 71 for details.

- Double-deck cart moves product at a convenient, workable height from the floor.
- Perfect for narrow aisles with a width of 19".
- All-welded construction provides for heavy duty stocking and produce operations.
- NSF Certified.



95661



## ► Utility Stock Truck

Model No	Size W-H-L	Weight Capacity	Top Shelf Height	Shelf Spacing	Ship Lbs.
96134BH	21" x 41½" x 47"	700 lbs.	30"	20¾"	42

Four 5" plate type swivel casters.

Top shelf measures 19"W x 40"L without bumpers.

**Handle and Corner Bumpers are standard equipment.**

- Double-deck stock truck moves product at a convenient, workable height from the floor.
- Perfect for narrow aisles with a width of 19".
- All-welded construction provides for heavy duty stocking and produce operations.



96134BH



# Produce Carts

## ► Wet Produce Cart - Heavy Duty



1408 • 1410



Model No	Size W-H-L	Weight Capacity	Number Of Casters	Top Shelf Height	Shelf Spacing	Ship Lbs.
<b>Carts w/ Two (2) Removable Pans</b>						
1408	21" x 41" x 48½"	1200 lbs.	6	30"	19¼"	64
1410	29" x 41" x 50½"	1000 lbs.	6	30"	19¼"	69

Above units come equipped with a full perimeter bumper on the top shelf. Six 5" plate type casters; four swivel, two rigid.

**Options:** Options may not be NSF Certified. Contact the factory.

"CL(B)" - See page 71 for details.

- This Wet Produce Truck helps minimize the mess of transporting produce by retaining moisture and debris.
- With two reinforced removable drip pans, this unit allows you to contain as well as remove unwanted moisture promoting a clean, sanitary area.
- Each removable shelf is reinforced with a heavy-duty, channel-enforced frame supported by four sturdy posts (one located at each corner).
- NSF Certified.

## ► Wet Produce Cart - Standard



97126



Model No	Size W-H-L	Weight Capacity	Number Of Casters	Top Shelf Height	Shelf Spacing	Ship Lbs.
<b>Cart w/ One (1) Removable Pan</b>						
97126	24¾" x 38" x 52"	700 lbs.	4	30"	20"	52

Above unit has removable pan on top shelf with heavy duty tubular base.

Four 5" plate type casters; two swivel, two rigid.

**Options:** Options may not be NSF Certified. Contact the factory.

"B", "CL(B)", "PB" -- See page 71 for details.

- Double-deck cart moves product at a convenient, workable height from the floor.
- Perfect for narrow aisles with a width of 24¾".
- All-welded construction provides for heavy duty stocking and produce operations.
- NSF Certified.

## ► Produce Crisping Cart

Model No.	Size W-H-L	Basket Capacity	Runner Spacing	Ship Lbs.
<b>Stationary Unit - Equipped With Drip Pan &amp; Adjustable Feet</b>				
1315	32½" x 81½" x 26"	8	10¾"	42
<b>Mobile Units - Equipped With Drip Pan</b>				
1316	32½" x 86½" x 26"	8	10¾"	60
95136	32½" x 76" x 26"	7	10¾"	58
<b>Crisping Basket - Not NSF Certified</b>				
0307	26" x 9" x 29"			8

Mobile units: Four 5" plate type casters; two swivel, two swivel with brake.

All units accept Nestier, Buckhorn®, and Lewis chill baskets 26" x 29".

- Allows quick, easy access to all crisping baskets.
- Mobile unit can be filled in prep area and rolled into the cooler.
- Lifetime Guarantee against rust and corrosion, superior for coolers and freezers.
- NSF Certified.



1316



## ► Mobile Merchandiser

Model No.	Position	Size L-H-W	Weight Capacity	Ship Lbs.
1407	Upright / Display	43" x 43½" x 24"	1000 lbs.	45
	Flat / Storage	48" x 19" x 24"		

Four heavy duty, plate casters with Polyurethane tread; two: 2" x 5" rigid with brake, 1⅜" x 5" swivel.

- Show off your merchandise, not your merchandiser.
- Vertical adjustment from flat, to 30° to 45° degrees providing three different, attractive displays.
- Folds flat and stores upright to save space.
- Use multiple units to create larger displays.
- Has 8 square feet of merchandising area... Takes up 3½ square feet of storage space.
- Lifetime Guarantee against rust and corrosion.



1407



# Lug Dollies

## ► Lug Dollies - Heavy Duty



Model No.	Size W-H-D	Lug Capacity	Ship Lbs.
<b>Heavy Duty - Accepts 15½" x 8¾" x 25" Lug (Not Included)</b>			
1261	18⅞" x 27½" x 21"	2	24
1262	18⅞" x 52" x 26½"	4	36
1263	18⅞" x 72" x 26½"	6	40
1264	29½" x 62" x 33"	10	48

### Model #1261 Requires Stacking Lugs.

#1261, #1262, & #1263: Four 5" plate type swivel casters.

#1264: Four 5" plate type casters; two swivel, two rigid.

**Options:** Options may not be NSF Certified. Contact the factory.

"CL(B)" (#1261, #1262 & #1263 only) — See page 71 for details.

Model No.	Size W-H-D	Lug Capacity	Ship Lbs.
<b>Standard - Accepts 15½" x 8¾" x 25" Lug (Not Included)</b>			
1265	16¾" x 19" x 26"	1	11
1266	16¾" x 33" x 29¼"	2	18
99304*	17¼" x 41½" x 28"	3	21
1267	Handle for #1265 & #1266 (bolted on)		

### Standard - With Welded Handle

1265H*	16¾" x 36½" x 28¾"	1	14
1266H*	16¾" x 36½" x 30½"	2	17.5

Four 5" stem type swivel casters.

\* Not NSF Certified.

**Options:** Options may not be NSF Certified. Contact the factory.

"CL(A)", "MD" - See page 71 for details.



## ► Lug Dollies - Economy

Model No.	Lug Cap.	Size W-H-D	Ship Lbs.
6265	1	16¾" x 19" x 26"	10
6266	2	16¾" x 33" x 29¼"	16
97205*	3	18⅞" x 42" x 26"	23
6262	4	18⅞" x 51" x 26"	25
97253*	5	18⅞" x 61" x 26"	28
6263	6	18⅞" x 71" x 26"	31

Four 5" stem type swivel casters.

\* Not NSF Certified.

**Options:** Options may not be NSF Certified. Contact the factory.

"CL(A)" - See page 71 for details.

- Accepts standard lugs (15½"W x 8¾"H x 25"L).
- Ideal for bulk food transporting.
- NSF Certified.



## Bulk Cart • Frame & Tubs

Model No.		Size W-H-D	Ship Lbs.
<b>***** All Items Are Sold Separately *****</b>			
<b>a. 2¼ Bushel • 16.5 Gallon</b>			
99521	Dolly	20¼" x 33" x 26¼"	26
0300	Tub	19¼" x 13¾" x 26"	8
<b>b. 4 Bushel • 30 Gallon</b>			
99271	Dolly	21" x 28¼" x 30¼"	22
0381	Tub	21¼" x 15¾" x 32¾"	12
0381L	Lid	22½" x 2" x 34"	9
<b>c. 6 Bushel • 41 Gallon</b>			
99272	Dolly	22" x 25" x 29"	22
0363	Tub	23¼" x 20" x 32¼"	17
0363L	Lid	24½" x 2" x 33½"	6
<b>d. 8 Bushel • 57 Gallon</b>			
99273	Dolly	23¼" x 24" x 34½"	23
0360	Tub	24½" x 23" x 36¼"	23
0360L	Lid	25" x 2½" x 37½"	12.5
<b>e. 9 Bushel • 66 Gallon</b>			
99274	Dolly	27½" x 25" x 38¼"	26
0382	Tub	29½" x 19" x 41½"	27
0382L	Lid	29½" x 2½" x 41½"	10

Four 5" stem type swivel casters.  
All carts with tubs are 36½" high.

**Options:** Options may not be NSF Certified. Contact the factory.  
"CL(A)" - See page 71 for details.



Lid



a.

- The perfect "bulk" cart for every department.
- All welded construction.
- Lifetime Guarantee against rust and corrosion.

Note: Tubs and Lids are excluded from guarantees.



## Mega Movers

Model No.		Size W-H-L	Ship Lbs.
<b>***** All Items Are Sold Separately *****</b>			
<b>f. 14 Bushel • 17 Cubic Feet • 115 Gallon</b>			
51619	Dolly	24½" x 8" x 36½"	30
0814	Tub	32" x 27½" x 44"	35
(Tub on Dolly = 35¾"H)			
<b>g. 16 Bushel • 18.6 Cubic Feet • 135 Gallon</b>			
51620	Dolly	24½" x 9" x 36½"	30
0816	Tub	32" x 30" x 44"	38
(Tub on Dolly = 36¾"H)			
<b>h. 18 Bushel • 24 Cubic Feet • 155 Gallon</b>			
51621	Dolly	26½" x 9" x 38¾"	31
0818	Tub	34" x 30" x 46"	41
(Tub on Dolly = 38¼"H)			
<b>i. 20 Bushel • 25.6 Cubic Feet • 170 Gallon</b>			
51622	Dolly	28½" x 9" x 44½"	33
0820	Tub	36" x 31" x 52"	46
(Tub on Dolly = 39¾"H)			

Six 5" plate type casters; four swivel, two rigid.



Base



Tubs

**Tub and Base are not joined for easy cleaning.**

### Aluminum Base

- Lifetime Guarantee against rust and corrosion.
- Six wheel design allows for zero turning radius.
- 1500 lbs. Weight Capacity

### FDA Tubs

- FDA Compliant tubs.
- Heavy wall in "all natural white" color.
- Seamless molded Polyethylene body.
- Smooth finish with rounded corners.

Note: Tubs and Lids are excluded from guarantees.

# Universal Carts

## ▶ Universal Lug Dolly

Model No.	Size W-H-D	Lug Capacity	Between Shelf Space	Ship Lbs.
1276	18½" x 36" x 26"	3	10"	26
1277	18½" x 47" x 26"	4	10"	30
1279	18½" x 68" x 26"	6	10"	35

Four 5" stem type swivel casters.

**Options:** Options may not be NSF Certified. Contact the factory.

"CL(A)" - See page 71 for details.

- Designed to hold lugs by the bottom, not the lip allowing the storage of various sizes of lugs.
- Lifetime Guarantee against rust and corrosion.
- NSF Certified.



1279



1277



99251



RGY16825



0361

## ▶ Lug Storage Dolly & Lugs

Model No.	Size W-H-D	With Handle	Ship Lbs.
99251	17" x 6" x 26"	No	13

Four 3" x 1¾" plate type swivel casters.

**Not NSF Certified.**

Model No.	Size W-H-L	Color	Ship Lbs.
RGY16825	15½" x 8¾" x 25"	gray	4
0361	Lid For #RGY16825	gray	1

Food Approved Molded Poly • Formed Cross-Stacking Bottom'

**Not NSF Certified.**

## ► Universal Cart - Heavy Duty

Model No.	Size W-H-D	Number Of Shelves	Between Shelf Space	Ship Lbs.
1356	20 <sup>7</sup> / <sub>8</sub> " x 67" x 27"	6	10 <sup>1</sup> / <sub>2</sub> "	47
1357 *	28 <sup>1</sup> / <sub>2</sub> " x 69" x 32"	7	9"	60
1358 **	20 <sup>7</sup> / <sub>8</sub> " x 67" x 27"	8	7 <sup>1</sup> / <sub>4</sub> "	46

Four 5" plate type swivel casters.

\* Model #1357 is a double capacity unit.

\*\* Model #1358 will not accept lugs.

**Options:** Options may not be NSF Certified. Contact the factory.

"B", "CL(B)", "MD", "PB", "VB" - see page 71 for details.

### PAN SIZES:

10" x 20" Roast & Bake Pans • 20" x 22" Roast & Bake Pans • 18" x 26" Roasting Pans • 18" x 26" Bun Pans • 18" x 13" Bun Pans • 12" x 20" Steam Table Pans • 20<sup>3</sup>/<sub>4</sub>" x 25<sup>1</sup>/<sub>2</sub>" European Std. GastroNorm Pans • 15" x 20" Service Tray • 14" x 18" Service Tray • 20" x 20" Cup & Glass Racks

- Ideal multipurpose rack for all departments.
- Accepts many sizes of platters, pans, boxes and lugs.
- All welded construction with 5" platform type casters.
- Lifetime Guarantee against rust and corrosion.
- NSF Certified.



1357



## ► Universal Cart - Standard

Model No.	Size W-H-L	Pan Capacity	Runner Spacing	Ship Lbs.
<b>For Platters, Pans, or Boxes Up To 18"W x 26"L</b>				
1356M	20 <sup>7</sup> / <sub>8</sub> " x 67" x 27"	6	10 <sup>1</sup> / <sub>2</sub> "	45

Four 5" stem type swivel casters.

**Options:** Options may not be NSF Certified. Contact the factory.

"CL(A)", "VB" - see page 71 for details.

### PAN SIZES:

10" x 20" Roast & Bake Pans • 20" x 22" Roast & Bake Pans • 18" x 26" Roasting Pans • 18" x 26" Bun Pans • 18" x 13" Bun Pans • 12" x 20" Steam Table Pans • 20<sup>3</sup>/<sub>4</sub>" x 25<sup>1</sup>/<sub>2</sub>" European Std. GastroNorm Pans • 15" x 20" Service Tray • 14" x 18" Service Tray • 20" x 20" Cup & Glass Racks

- Ideal for transporting various sized platters, trays, boxes, and lugs.
- Heavy duty extruded oval tubing shelves provide easy product access and selection.
- NSF Certified.



1356M



# Platter Racks

## ▶ Platter Rack • Angle Guide - Heavy Duty



1348



1340

Model No	Size W-H-D	Platter Capacity	Platter Size	Runner Spacing	Ship Lbs.
<b>Single</b>					
<b>Designed for 10" x 30" Platters</b>					
1340	13" x 39" x 30"	6	10" x 30"	5"	23
1343	13" x 69" x 30"	10	10" x 30"	6"	32
1345	13" x 69" x 30"	12	10" x 30"	5"	35
<b>Designed for 12" x 30" Platters</b>					
1346	15¼" x 39" x 30"	6	12" x 30"	5"	24
1348	15¼" x 69" x 30"	10	12" x 30"	6"	43
1347	15¼" x 69" x 30"	12	12" x 30"	5"	43
Four 5" stem type swivel casters.					
<b>Double</b>					
1349	25½" x 71½" x 30"	18	10" x 30"	7½"	70
1350	29½" x 71½" x 30"	18	12" x 30"	7½"	71
Four 5" plate type swivel casters.					

**Options:** Options may not be NSF Certified. Contact the factory.

**Single:** "CL(A)", "MD", "PS", "VB" - see page 71 for details.

**Double:** "B", "CL(B)", "MD", "PS" (requires two), "VB" - see page 71 for details.



6347



6348

## ▶ Platter Rack • Angle Guide - Standard

Model No.	Size W-H-D	Platter Size	Platter Capacity	Runner Spacing	Ship Lbs.
6345	13" x 69" x 30"	10" x 30"	12	5"	34
6348	15¼" x 69" x 30"	12" x 30"	10	6"	33
6347	15¼" x 69" x 30"	12" x 30"	12	5"	36
Four 5" stem type swivel casters.					

**Options:** Options may not be NSF Certified. Contact the factory.

"CL(A)", "PS", "VB" — See page 71 for details.

- Ideal for platter transport to and from the meat department.
- Heavy duty extruded angles provide easy product access and selection.
- Approved for use in freezers, coolers, as well as packaging and storage areas.





## ► Heavy Duty Platter Rack

Model No	Size W-H-D	Platter Capacity	Platter Size	Runner Spacing	Ship Lbs.
1161	15¾" x 39½" x 26½"	6	12" x 26"	5"	30
1162	21" x 39½" x 26½"	6	18" x 26"	5"	30
1163	15¾" x 69½" x 26½"	12	12" x 26"	5"	42
1164	21" x 69½" x 26½"	12	18" x 26"	5"	52

Four 5" plate type swivel casters.

**Options:** Options may not be NSF Certified. Contact the factory.

"B", "CL(B)", "M6", "MD", "PB" - See page 71 for details.



1162



1164



## ► Universal Platter Rack - Heavy Duty

Model No.	Size W-H-D	Number Of Shelves	Between Shelf Space	Ship Lbs.
<b>Accepts 10" x 30" or 12" x 30" Platters</b>				
1354	16" x 42" x 32½"	5	7¼"	37
1355	16" x 67" x 32½"	8	7¼"	51

Four 5" plate type swivel casters.

**Options:** Options may not be NSF Certified. Contact the factory.

"B", "CL(B)", "MD", "PB", "VB" - See page 71 for details.



1355



1354



## ► Universal Platter Rack - Standard

Model No.	Size W-H-D	Number Of Shelves	Shelf Spacing	Ship Lbs.
<b>For 10" - 12" Platters Up To 30" In Length</b>				
6354	15½" x 42" x 32"	5	7¼"	34
1355M	15½" x 67" x 32"	8	7¼"	45

Four 5" stem type swivel casters.

**Options:** Options may not be NSF Certified. Contact the factory.

"CL(A)", "VB" - See page 71 for details.



1355M



6354



# Folding Carts

## ► Folding Utility Cart

Model No	Size Unfolded	Size Folded	Weight Capacity	Ship Lbs.
96856	16" x 64" x 64¾"	16" x 14" x 64¾"	1500 lbs.	76

Four 5" x 1¼" polyurethane, plate type swivel casters and two 6" x 2" polyurethane plate type rigid casters.

- **Effortless Stocking Capability**
  - Ideal for transporting heavy loads from the back room to the floor area or cooler.
  - Big enough to stock a complete area with one trip!
- **Completely Portable** - Six wheel design allows the unit to turn on a dime.
- **Guaranteed Maintenance Free**
  - **Lifetime Guarantee** against rust and corrosion.
  - **Five-Year Construction Guarantee.**
- **Maximum Storage Space**
  - Stores upright (on-end) to maximize available storage space.



96856



## ► Folding "L" Cart

Model No.	Size W-H-L	Deck Height	Number Of Casters	Ship Lbs.
95370	20" x 52¾" x 55¼"	9"	6	53
95241	18" x 63" x 62"	9½"	6	54

Six plate type casters; four 5" swivel and two 6" x 2" rigid.

- Folds up for easy storage.
- Has 7½ square feet of deck space... Takes up less than 2 square feet of storage space.
- **1200 lbs. Weight Capacity.**
- For transporting heavy loads from the back room to the floor.
- Lifetime Guarantee against rust and corrosion, superior for coolers & freezers.



95370

95241



## ► Low Boy Stock Cart

Model No.	Size W-H-L	Weight Capacity	Deck Height	Number Of Casters	Ship Lbs.
1183	16" x 41" x 54"	1000 lbs.	9½"	6	40.5
1184	14" x 40" x 39"	1000 lbs.	7¾"	4	23

**Model #1183:** Six plate type casters; four 5" swivel, two 6" rigid.

**Model #1184:** Four 5" plate type casters; two swivel, two rigid.

**Each Unit Has A Removable Handle.**

- Designed for transporting heavy loads from the backroom to the floor.
- Rounded front helps protect walls and displays.
- Lifetime Guarantee against rust and corrosion, superior for coolers & freezers.
- NSF Certified.



1184

1183



## Bulk Delivery Truck

Model No.	Size W-H-L	Position	Weight Capacity	Ship Lbs.
BDT18568	18" x 63" x 61"	Unfolded	1200 lbs.	1041
	18" x 17" x 61"	Folded		
Six 8" x 2" plate type casters; four swivel, two rigid.				
BDT18566	18" x 61" x 61"	Unfolded	1200 lbs.	96
	18" x 15" x 61"	Folded		
Six 6" x 2" plate type casters; four swivel, two rigid.				

### Options:

**Removable Handle** — Add "R" suffix to model #.

**Dual Brake System** — Add "B" suffix to model #.

For Center Rigid Wheels **\*\* New Carts Only - Not for Retro-Fit \*\***

- Big enough to transport enough product to stock a complete area, this folding delivery truck allows quick, convenient stocking.
- Vertical cart storage allows 100% accessibility for your next delivery.
- Maneuverable — zero turning — easier for narrow aisles and coolers.
- Solid integrated deck.
- Center rigid casters allow for zero turning radius.
- Lifetime Guarantee against rust and corrosion.

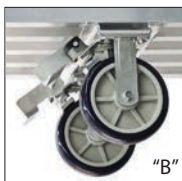

BDT18566



BDT18568

## Aluminum Platform Truck

Model No.	Size W-H-L	Deck Size	Weight Capacity	Ship Lbs
<b>Platform Truck With Smooth Deck</b>				
PT2436S6	24" x 41" x 39"	24" x 36"	2600 lbs.	54
PT2448S6	24" x 41" x 51"	24" x 48"	2600 lbs.	58
PT3048S6	30" x 41" x 51"	30" x 48"	2600 lbs.	65
PT3060S6	30" x 41" x 63"	30" x 60"	2600 lbs.	75
PT3660S6	36" x 41" x 63"	36" x 60"	2600 lbs.	89
PT3672S6	36" x 41" x 75"	36" x 72"	2600 lbs.	93
<b>Platform Truck With Tread Plate Deck</b>				
PT2436P6	24" x 41" x 39"	24" x 36"	2600 lbs.	56
PT2448P6	24" x 41" x 51"	24" x 48"	2600 lbs.	60
PT3048P6	30" x 41" x 51"	30" x 48"	2600 lbs.	67
PT3060P6	30" x 41" x 63"	30" x 60"	2600 lbs.	78
PT3660P6	36" x 41" x 63"	36" x 60"	2600 lbs.	89
PT3672P6	36" x 41" x 75"	36" x 72"	2600 lbs.	95

Four 6"x2" heavy duty polyurethane tread plate casters; two swivel, two rigid. Equipped with (1) handle, optional extra/replacement handles sold below.

### Options:

"CL(C)", "PB", "PP(C)" — see page 71 for details.

**Caster Upgrade** -- Replace last digit of model # with "8".

Consists of four 8" x 2" heavy duty polyurethane tread plate casters — two swivel, two rigid.

**Options:** "CL(E)" — see page 71 for details.

### Extra Handle

60328	For 24" Wide Units	11
60329	For 30" Wide Units	11.5
60330	For 36" Wide Units	13

### Options:

**Extra Handle Welded in Place** -- Add "PP" suffix to model #.



Smooth Deck



Tread Plate Deck  
(shown with caster upgrade)



# Trucks



95762



96055 shown with two 96055RS



96055RS



1152



1430



## ► U-Boat

Model No	Size W-H-L	Weight Capacity	Ship Lbs.
<b>U-Boats</b>			
95762	18" x 52¼" x 60"	1500 lbs.	51
96055	20" x 52¼" x 60"	1500 lbs.	59

Six plate type casters; four 5" x 1¼" swivel, two 6"x 2" rigid.

### Removable Shelves For U-Boats - Listed Above

95762RS	For #95762	13
96055RS	For #96055	15

Removable shelves are reinforced with a solid cover.

## ► Boxed Beef Truck

Model No	Size D-H-L	Number Of Shelves	Shelf Spacing	Ship Lbs.
1151	27" x 71" x 63"	2	29"	118
1152	27" x 71" x 63"	3	top= 28" bottom = 29"	123

Four 6" plate type casters; two swivel with brake, two rigid.

**Options:** Options may not be NSF Certified. Contact the factory.

"B", "PB", "&" "VB" — see page 71 for details.

- Use in coolers, freezers, and dry storage.
- Transport heavy loads up to 2,600 lbs.
- Heavy Duty 6" plate type casters.
- All welded, heavy duty aluminum construction.
- Lifetime Guarantee against rust and corrosion.
- NSF Certified.

## ► Uni-T Truck

Model No	Size D-H-L	Wheel Size	Shelf Spacing	Ship Lbs.
1430	24" x 68" x 58"	6"	38¼"	92
1431	24" x 70" x 58"	8"	38¼"	114

Model #1430: Four 6" plate type casters; two swivel, two rigid.

Model #1431: Four 8" plate type casters; two swivel, two rigid.

**Options:** Options may not be NSF Certified. Contact the factory.

"B", #1430=CL(C), #1431=CL(E) "PB", &" "VB" -- see page 71 for details.

- Use in coolers, freezers, and dry storage.
- Transport heavy loads up to 2,000 lbs.
- All welded, heavy duty aluminum construction.
- Lifetime Guarantee against rust and corrosion.
- NSF Certified.

## ▶ Wall Mount Mat Rack

Model No.	Size W-H-D	Weight Capacity	Ship Lbs.
52677	42" x 10" x 7"	**	17

\*\* Determined by method of installation and type of wall

Labor saving mat rack keep mats off the floor for easy, efficient cleaning.

- Ideal for power washing.
- Hooks secure perforated mats for storage and cleaning.
- Lifetime Guarantee against rust and corrosion.

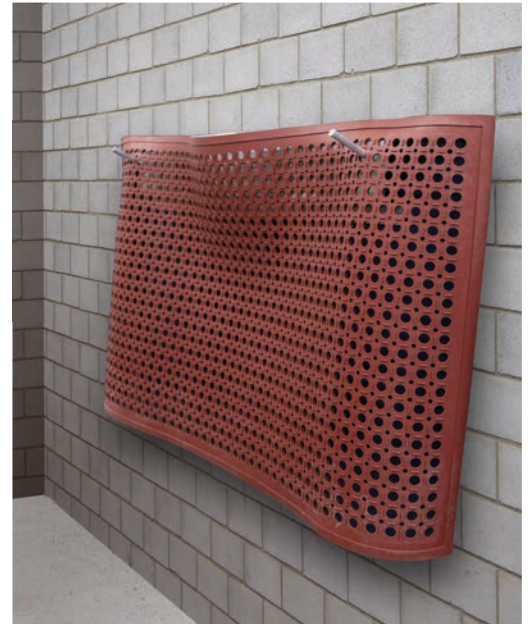

52677

Like all New Age products, the Mat Rack can be easily customized to accommodate your mat. All you need to get started is a few key measurements.

1. Length and Width of mat.
2. Diameter of holes in the mat.
3. Mat hole spacing.

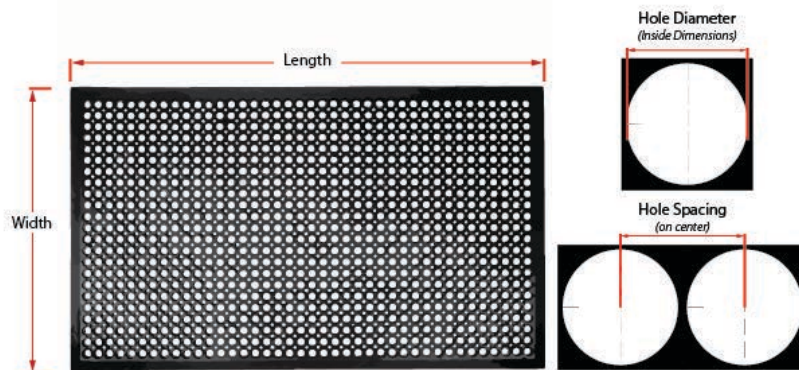

## ▶ Mat Cart

Model No.	Size W-H-D	Weight Capacity	Ship Lbs.
<b>All Welded</b>			
99360	41½" x 40" x 27½"	500 lbs.	40
Four 5" plate type swivel casters; two with brake.			
<b>Knocked-Down</b>			
51087	24" x 45¼" x 36"	500 lbs.	37
Four 5" plate type swivel casters with brake.			

- Labor saving mobile mat carts keep mats off of the floor for easy, efficient cleaning.
- Hooks secure perforated mats for storage and cleaning.
- Center horizontal bars hold solid mats. (all welded unit only)
- Open design allows use of waste container. (K.D. model only)
- Ideal for power washing mats on the cart.
- Lifetime Guarantee against rust and corrosion.



99360



51087



# Casters

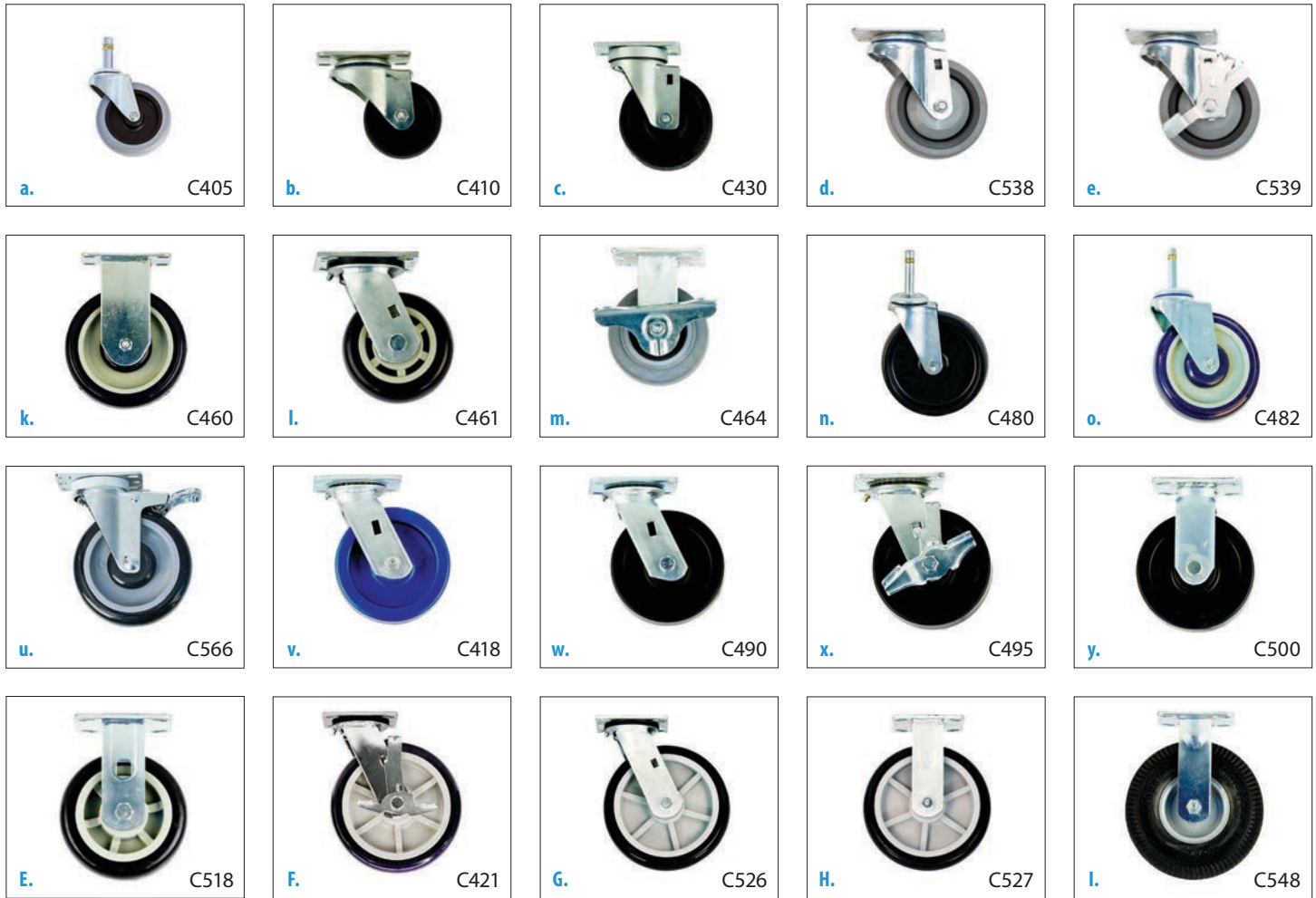

Model No.	Caster Size	Caster Type	Caster Description	Wheel Material	Maximum Temperature	Weight Capacity (lbs.)	Stem Diameter/ Hole Pattern
a. C405	3" x 7/16"	Stem	Swivel	Polyurethane Wheel	180°	125	7/16" Stem
b. C410	3" x 13/8"	Plate	Swivel	Polyolefin Wheel	140°	200	13/4" x 3"
c. C430	4" x 1 1/2"	Plate	Swivel	Hi-temp Wheel (above 400°)	550° intermittent 425° continuous	400	13/4" x 3"
d. C538	4" x 1 1/4"	Plate	Swivel	TPR Wheel,	140°	250	13/4" x 3"
e. C539	4" x 1 1/4"	Plate	Swivel w/ brake	TPR Wheel	140°	250	13/4" x 3"
f. C440	5" x 1 3/8"	Stem	Swivel w/ brake	Polyolefin Wheel	140°	300	1" Stem
g. C447	5" x 1 3/8"	Stem	Swivel w/ brake	Polyolefin Wheel	140°	200	1/2" Stem
h. C450	5" x 1 3/8"	Plate	Swivel	Polyolefin Hub, Polyurethane Tread	180°	250	13/4" x 3"
i. C453	5" x 1 1/4"	Plate	Swivel	Polyolefin Hub, Polyurethane Tread	140°	225	13/4" x 3"
j. C455	5" x 1 3/8"	Plate	Swivel w/ brake	Polyolefin Hub, Polyurethane Tread	180°	250	13/4" x 3"
k. C460	5" x 1 3/8"	Plate	Rigid	Polyolefin Hub, Polyurethane Tread	180°	250	13/4" x 3"
l. C461	5" x 2"	Plate	Swivel	Polyolefin Hub, Polyurethane Tread	140°	800	3" x 3"
m. C464	5" x 2"	Plate	Rigid w/ brake	Polyolefin Hub, TPR Tread	120°	350	3" x 3"
n. C480	5" x 1"	Stem	Swivel	Polyolefin Wheel	130°	135	7/16" Stem
o. C482	5" x 1 3/8"	Stem	Swivel	Polyolefin Hub, Polyurethane Tread	180°	250	7/16" Stem
p. C483	5" x 1 3/8"	Stem	Swivel w/ brake	Polyolefin Hub, Polyurethane Tread	180°	250	7/16" Stem
q. C485	5" x 1"	Stem	Swivel w/ brake	Polyolefin Wheel	130°	135	7/16" Stem
r. C557	5" x 1 1/4"	Stem	Swivel	TPR Wheel, Synthetic Rig	150°	250	7/16" Stem
s. C558	5" x 1 1/4"	Plate	Swivel	TPR Wheel, Synthetic Rig	150°	250	13/4" x 3"
t. C558B	5" x 1 1/4"	Plate	Swivel w/brake	TPR Wheel, Synthetic Rig	150°	250	13/4" x 3"
u. C566	5" x 1 3/8"	Plate	Swivel w/total lock	Polyolefin Hub, Polyurethane Tread	180°	350	13/4" x 3"

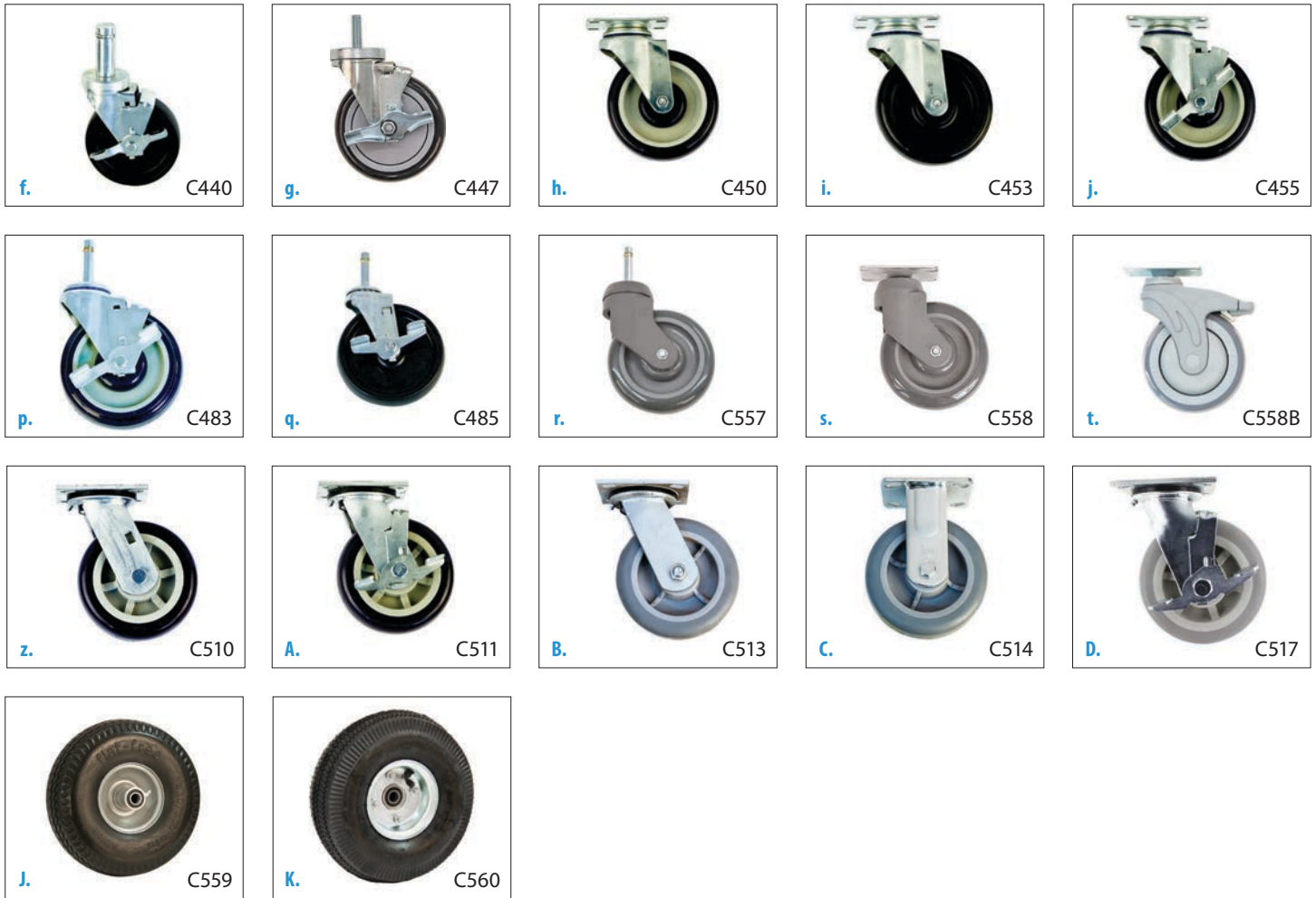

	Model No.	Caster Size	Caster Type	Caster Description	Wheel Material	Maximum Temperature	Weight Capacity (lbs.)	Stem Diameter/ Hole Pattern
v.	C418	6" x 2"	Plate	Swivel	K-Urethane Wheel	180°	700	3" x 3"
w.	C490	6" x 2"	Plate	Swivel	Polyolefin Wheel	190°	700	3" x 3"
x.	C495	6" x 2"	Plate	Swivel w/ brake	Polyolefin Wheel	190°	700	3" x 3"
y.	C500	6" x 2"	Plate	Rigid	Polyolefin Wheel	190°	700	3" x 3"
z.	C510	6" x 2"	Plate	Swivel	Polyolefin Hub, Polyurethane Tread	140°	700	3" x 3"
A.	C511	6" x 2"	Plate	Swivel w/ brake	Polyolefin Hub, Polyurethane Tread	140°	700	3" x 3"
B.	C513	6" x 2"	Plate	Swivel	TPR "Softie" A70	150°	800	3" x 3"
C.	C514	6" x 2"	Plate	Rigid	TPR "Softie" A70	150°	800	3" x 3"
D.	C517	6" x 2"	Plate	Swivel w/ brake	TPR "Softie" A70	150°	800	3" x 3"
E.	C518	6" x 2"	Plate	Rigid	Polyolefin Hub, Polyurethane Tread	140°	700	3" x 3"
F.	C421	8" x 2"	Plate	Swivel w/ brake	Polyolefin Hub, Polyurethane Tread	185°	900	3" x 3"
G.	C526	8" x 2"	Plate	Swivel	Polyolefin Hub, Polyurethane Tread	185°	900	3" x 3"
H.	C527	8" x 2"	Plate	Rigid	Polyolefin Hub, Polyurethane Tread	185°	800	3" x 3"
I.	C548	8" x 2"	Plate	Rigid	Metal Hub, Carefree	140°	300	3" x 3"
J.	C559	10" x 3½"	Axle	Flat Free	Steel Hub, Non-scuff Polyurethane	N/A	400	⅝" DIA
K.	C560	10" x 3½"	Axle	Pneumatic	Steel Hub / 4-ply Rubber	N/A	400	⅝" DIA

# Product Options & Accessories - Options may not be NSF Certified. Contact the factory.

## "B" - Corner Bumpers (4) • Add "B" suffix to the model #.

Non-marking gray rubber, mounted to the corners of the unit's base.

Note: This option adds 2" to the width and depth of the unit .

**Corner bumpers available on full frame units only.** Check specific model options for availability.



## "CL" - Caster Locks (2)

(A) 5" stem caster  $7/16$ " dia. — Add "CL" suffix to the model #.

(B) 5" platform caster — Add "CL" suffix to the model #.

(C) 6" platform caster — Add "CL" suffix to the model #.

(E) 8" platform caster — Add "CL" suffix to the model #.



## "E" - Solid Base • Add "E" suffix to the model #.

Solid aluminum sheet welded to the top of the unit's base.

**MUST be factory installed.**



## "M6" - Caster Upgrade • Add "M6" suffix to the model #.

Upgrade from 5" platform type casters to 6" platform type casters. May change height of racks.

## "MD" - Medical Caster Upgrade • Add "MD" suffix to the model #.

Upgrade to 5" medical grade casters. Caster Locks are unavailable for some models.

**\*\*\* Caster upgrades are not available for all products. \*\*\***



## "PB" - Perimeter Bumpers • Add "PB" suffix to the model #.

Non-marking gray rubber strip, usually affixed around the unit's base.

**Note:** This option adds 2" to the width and depth of the unit.

**MUST be factory installed.**



## "PP" - Prison Package

(A) Tamper Resistant Screws — Add "PP" suffix to the model #.

(B) Tamper Resistant Screws, Welded Hinges, Extra Interior Bracing (reduces pan capacity), 6" Caster Upgrade, Padlock Holes in Door — Add "PP" suffix to the model #.

(C) Tamper Resistant Screws / All Welded Handle — Add "PP" suffix to the model #.



## "PS" - Pan Stop • Add "PS" suffix to the model #.

Aluminum strap welded to the rear of the unit — Prevents pans from pushing off the back of the unit.

**MUST be factory installed.**



## "VB" - Vertical Bumpers (4) • Add "VB" suffix to the model #.

Non-marking black rubber strips, usually 8" long, mounted near the bottom of the unit's uprights.

**Note: This option adds 1" to the width and depth of the unit.**



## #1359 - Rack Cover (Clear, 12 mil.) • 23"W x 64"H x 28"D

Universal End-Load/Side-Load Rack Cover.

Clear for product visibility.

**Three full zippers.**





## Ordering Information

**Prices:** For current pricing and additional product information please visit our website at [www.NewAgeIndustrial.com](http://www.NewAgeIndustrial.com), AutoQuotes®, or contact the factory. Specifications and prices are subject to change without prior notice.

**Quotations:** Quotations are valid for 15 days from the date of the quotation. Changes in raw materials or economic factors are beyond our control. New Age reserves the right to increase prices with 30 days notice or at the time of the order confirmation.

**Cancellations:** Cancelled orders within two weeks of scheduled shipment are subject to a cancellation charge of 25% of the total purchase order.

**Terms of Payment:** Payment in full 30 days after shipment or C.O.D. at the discretion of New Age Industrial's Credit Department. If you are a new customer and are not listed in Dun & Bradstreet, please give us the name and address of three credit references and your bank, unless you prefer C.O.D. terms. We also accept Visa, Master Card, and American Express payments.

**Past due accounts are subject to 1.5% interest per month.**

**Damaged or Lost Goods:** It is the responsibility of the consignee's receiving agent to inspect equipment upon delivery. If you see your shipment is incomplete or damaged when you receive it make a notation on the freight bill — If the freight company will not allow you to do so, refuse shipment. If the damage is concealed, you must notify New Age within 15 days (including the day of delivery plus weekends and holidays). New Age will handle all claim paperwork for the customer.

**Returns:** Returned merchandise must be pre-approved with a RMA number assigned by New Age and noted on both the shipping label and bill of lading. Merchandise is to be returned with transportation charges prepaid and is subject to a 20% handling and inspection charge. **New Age reserves the right to refuse the return of any piece of equipment.**

**Acceptance:** Possession of Price List does not constitute an offer to sell. Orders are subject to acceptance by New Age Industrial.

**Custom Equipment:** All equipment not listed in this Price List shall be considered "custom". **POSITIVELY NO RETURNS will be accepted on "custom" built equipment.**

**NSF:** New Age Industrial Corp., Inc. food service products are manufactured and designed with high sanitary standards and most are listed by NSF International. For specific items, please refer to the latest NSF food service listing.



**Safety:** For the most current safety information, see [www.NewAgeIndustrial.com](http://www.NewAgeIndustrial.com) or call 800-255-0104.

## Guarantees

New Age Industrial Corporation, Inc. guarantees that the products listed in their most recent price list (casters, wheels, tubs, lugs, lids, fastening devices and accessories excluded) will not rust or corrode for the period of time the original purchaser owns it, provided the products are used within the listed restrictions.



The Lifetime Series, "Adjust-A-Shelf" Shelving and "Quick Change" Cantilever Shelving products are guaranteed for the LIFETIME of the original purchaser. They will be free from defects in material and workmanship and will not rust or corrode if used within the listed restrictions.



New Age Industrial Corporation, Inc. guarantees the original owner that its products will be free from defects in material and workmanship (when properly installed) for FIVE YEARS, provided the product has been used within the listed restrictions.



New Age Industrial Corporation, Inc. guarantees the original owner that its products will be free from defects in material and workmanship (when properly installed) for ONE YEAR, provided the product has been used within the listed restrictions.

## Restrictions

1. Your New Age product must be used solely for its intended purpose. Abuse of, misuse of, changes to, alteration of, or improper maintenance of original equipment shall void any warranty.
2. Your New Age product must not be loaded beyond the product's published uniformly distributed static load limit (capacity).
3. Your New Age product must be cleaned on a periodic basis every three to four weeks or be cleaned within accepted industry standards, following the generally accepted cleansing agent's instructions.
4. New Age shall not be liable for incidental, special, indirect, or consequential damages arising or resulting from misuse, use, inability to use, or from product defects or other tort.

If requested, the damaged product will be returned to New Age at the owner's expense for inspection and approval.

New Age Industrial Corporation, Inc.  
16788 US Hwy 36 • PO Box 520  
Norton, KS 67654

# Index

0116.....	43	1125A.....	44	1277.....	61	1375W.....	52	1854SB.....	41	21548ES24P.....	54
0117.....	34,37,38	1126.....	44	1279.....	61	1376.....	52	1854TB.....	40	21548ES30P.....	54
0118.....	33,34	1126A.....	44	1288.....	47	1377.....	52	1860HD.....	39	21548ES36P.....	54
0119.....	44	1127.....	44	1289.....	47	1378.....	52	1860SB.....	41	21824ES24P.....	54
0300.....	60	1127A.....	44	1290.....	14	1379.....	52	1860TB.....	40	21824ES30P.....	54
0307.....	27,58	1137.....	16	1290A.....	14	1380.....	52	1866HD.....	39	21824ES36P.....	54
0350.....	17	1139.....	16	1290WDW.....	13	1381.....	52	1866TB.....	40	21830ES24P.....	54
0351.....	17	1151.....	67	1291.....	14	1382.....	52	1872HD.....	39	21830ES30P.....	54
0360.....	60	1152.....	67	1292.....	14	1383.....	52	1872SB.....	41	21830ES36P.....	54
0360L.....	60	1161.....	64	1293.....	14	1384.....	52	1872TB.....	40	21836ES24P.....	54
0361.....	61	1162.....	64	1296.....	14	1407.....	58	1872UB.....	47	21836ES30P.....	54
0363.....	60	1163.....	64	12P.....	43	1408.....	57	2001.....	36	21836ES36P.....	54
0363L.....	60	1164.....	64	1303GGS.....	54	1410.....	57	2002.....	36	21842ES24P.....	54
0381.....	60	1171.....	27	1303GSC.....	54	1415.....	55	2003.....	36	21842ES30P.....	54
0381L.....	60	1172.....	27	1303GSCU.....	54	1416.....	55	2004.....	36	21842ES36P.....	54
0382.....	60	1174.....	27,35	1303GGSU.....	54	1420.....	55	2005.....	36	21848ES24P.....	54
0382L.....	60	1176A.....	28	13048GS.....	54	1430.....	67	2006.....	36	21848ES30P.....	54
0814.....	60	1179A.....	28	13048GSC.....	54	1431.....	67	2007.....	36	21848ES36P.....	54
0816.....	60	1181.....	31	13048GSCU.....	54	1440.....	32	2008.....	36	22024ES24P.....	54
0818.....	60	1182.....	31	13048GSU.....	54	1450.....	35	2009.....	36	22024ES30P.....	54
0820.....	60	1183.....	66	1305.....	8	1451.....	25	2010.....	36	22024ES36P.....	54
1021.....	37	1184.....	66	1306.....	8	1452.....	25	2012.....	36	22030ES24P.....	54
1021TB.....	38	1187.....	31	13060GS.....	54	1455.....	25	2013.....	36	22030ES30P.....	54
1022.....	37	1188.....	31	13060GSC.....	54	1461.....	1	2014.....	36	22030ES36P.....	54
1022TB.....	38	1192.....	30	13060GSCU.....	54	1461S.....	1	2015.....	36	22036ES24P.....	54
1023.....	37	1193.....	30	13060GSU.....	54	1481.....	5	2016.....	36	22036ES30P.....	54
1023TB.....	38	1194.....	30	13072GS.....	54	1482.....	5	2017.....	36	22036ES36P.....	54
1024.....	37	1195.....	32	13072GSC.....	54	1484.....	5	2018.....	36	22042ES24P.....	54
1024TB.....	38	1196.....	32	13072GSCU.....	54	1486.....	5	2019.....	36	22042ES30P.....	54
1025.....	37	1199.....	27,30-32	13072GSU.....	54	1490.....	55	2020.....	36	22042ES36P.....	54
1025TB.....	38	1200.....	35	1311.....	1	1501.....	36	2021.....	36	22048ES24P.....	54
1026.....	37	1201.....	35	1312.....	1	1505.....	6	2022.....	36	22048ES30P.....	54
1026TB.....	38	1202.....	35	1313.....	1	1507.....	6	2026.....	36	22048ES36P.....	54
1027.....	37	1203.....	35	1314.....	1	1509.....	6	2027.....	36	2430HD.....	39
1027TB.....	38	1204.....	35	1315.....	58	1530HD.....	39	2028.....	36	2430SB.....	41
1028.....	37	1205.....	35	1316.....	58	1530S.....	42	2029.....	36	2430TB.....	40
1028TB.....	38	1206.....	35	1321.....	1	1530SB.....	41	2030HD.....	39	2436HD.....	39
1030.....	37	1207.....	35	1322.....	1	1530TB.....	40	2030S.....	42	2436SB.....	41
1030TB.....	38	1208.....	35	1330.....	1	1536HD.....	39	2030SB.....	41	2436TB.....	40
1031.....	37	120T.....	52	1330S.....	1	1536S.....	42	2030TB.....	40	2436UB.....	43
1031TB.....	38	120W.....	52	1330U.....	7	1536SB.....	41	2031.....	36	2442HD.....	39
1041.....	37	1210.....	19	1330Z.....	7	1536TB.....	40	2032.....	36	2442SB.....	41
1041TB.....	38	1211.....	35	1331.....	1	1542HD.....	39	2033.....	36	2442TB.....	40
1042.....	37	1212.....	35	1331S.....	1	1542S.....	42	2036HD.....	39	2442UB.....	43
1042TB.....	38	1213.....	35	1331U.....	7	1542SB.....	41	2036S.....	42	2448HD.....	39
1043.....	37	1214.....	35	1331Z.....	7	1542TB.....	40	2036SB.....	41	2448SB.....	41
1043TB.....	38	1215.....	19	1332.....	1	1548HD.....	39	2036TB.....	40	2448TB.....	40
1044.....	37	1225.....	33	1332S.....	1	1548S.....	42	2036UB.....	43	2448UB.....	43
1044TB.....	38	1226.....	33	1332Z.....	7	1548SB.....	41	2042HD.....	39	2454HD.....	39
1045.....	37	1226NT.....	33	1333.....	1	1548TB.....	40	2042S.....	42	2454SB.....	41
1045TB.....	38	1227.....	33	1333S.....	1	1554HD.....	39	2042SB.....	41	2454TB.....	40
1046.....	37	1235.....	33	1333Z.....	7	1554SB.....	41	2042TB.....	40	2460HD.....	39
1046TB.....	38	1236.....	33	1334.....	1	1554TB.....	40	2042UB.....	43	2460SB.....	41
1047.....	37	1236NT.....	33	1334S.....	1	1560HD.....	39	2048HD.....	39	2460TB.....	40
1047TB.....	38	1237.....	33	1335.....	3	1560S.....	41	2048S.....	42	2460UB.....	43
1048.....	37	12436GS.....	54	1336.....	3	1560TB.....	40	2048SB.....	41	2466HD.....	39
1048TB.....	38	12436GSC.....	54	1337.....	3	1566HD.....	39	2048TB.....	40	2466SB.....	41
1050.....	37	12436GSCU.....	54	1338.....	3	1566TB.....	40	2048UB.....	43	2466TB.....	40
1050TB.....	38	12436GSU.....	54	1340.....	63	1572HD.....	39	2051.....	36	2472HD.....	39
1051.....	37	12448GS.....	54	1343.....	63	1572TB.....	40	2052.....	36	2472SB.....	41
1051TB.....	38	12448GSC.....	54	1345.....	63	1610.....	9	2054.....	36	2472TB.....	40
1061.....	37	12448GSCU.....	54	1346.....	63	1612.....	9	2054HD.....	39	2496HD.....	39
1061TB.....	38	12448GSU.....	54	1347.....	63	1620.....	31	2054SB.....	41	24ESA29.....	53
1062.....	37	12460GS.....	54	1348.....	63	1622.....	31	2054TB.....	40	24ES529.....	53
1062TB.....	38	12460GSC.....	54	1349.....	63	1630.....	27	2060HD.....	39	24P36KD.....	51
1063.....	37	12460GSCU.....	54	1350.....	63	1631.....	27	2060SB.....	41	24P48KD.....	51
1063TB.....	38	12460GSU.....	54	1354.....	64	1635.....	8	2060TB.....	40	24P60KD.....	51
1064.....	37	12472GS.....	54	1355.....	64	1637.....	8	2060UB.....	43	24P72KD.....	51
1064TB.....	38	12472GSC.....	54	1355M.....	64	1640.....	8	2062.....	36	24P84KD.....	51
1065.....	37	12472GSCU.....	54	1356.....	62	1642.....	8	2064.....	36	24P96KD.....	51
1065TB.....	38	12472GSU.....	54	1356M.....	62	1650.....	9	2066HD.....	39	24PBS36KD.....	51
1066.....	37	1250.....	33	1357.....	62	1655.....	9	2066SB.....	41	24PBS48KD.....	51
1066TB.....	38	1250CK.....	33	1358.....	62	1830HD.....	39	2066TB.....	40	24PBS60KD.....	51
1067.....	37	1251.....	33	1359.....	2,71	1830S.....	42	2072HD.....	39	24PBS72KD.....	51
1067TB.....	38	1254.....	33	1361.....	1	1830SB.....	41	2072SB.....	41	24PBS84KD.....	51
1068.....	37	1255.....	33	1371T.....	52	1830TB.....	40	2072TB.....	40	24PBS96KD.....	51
1068TB.....	38	1256.....	33	1371W.....	52	1836HD.....	39	2096HD.....	39	24SS36KD.....	51
1070.....	37	1256CK.....	33	1372W.....	52	1836S.....	42	21524ES24P.....	54	24SS48KD.....	51
1070TB.....	38	1257.....	33	1372W.....	52	1836SB.....	41	21524ES30P.....	54	24SS60KD.....	51
1071.....	37	1261.....	59	1373CL.....	52	1836TB.....	40	21524ES36P.....	54	24SS72KD.....	51
1071TB.....	38	1262.....	59	1373CT.....	52	1842HD.....	39	21530ES24P.....	54	24SS84KD.....	51
1121.....	44	1263.....	59	1373T.....	52	1842S.....	42	21530ES30P.....	54	24SS96KD.....	51
1121PR.....	44	1264.....	59	1373W.....	52	1842SB.....	41	21530ES36P.....	54	24SSB36KD.....	51
1122.....	44	1265.....	59	1374CL.....	52	1842TB.....	40	21536ES24P.....	54	24SSB48KD.....	51
1122PR.....	44	1265H.....	59	1374CT.....	52	1848HD.....	39	21536ES30P.....	54	24SSB60KD.....	51
1123.....	44	1266.....	59	1374T.....	52	1848S.....	42	21536ES36P.....	54	24SSB72KD.....	51
1123PR.....	44	1266H.....	59	1374W.....	52	1848SB.....	41	21542ES24P.....	54	24SSB84KD.....	51
1124.....	44	1267.....	59	1375.....	52	1848TB.....	40	21542ES30P.....	54	24SSB96KD.....	51
1125.....	44	1276.....	61	1375T.....	52	1854HD.....	39	21542ES36P.....	54	24US36KD.....	51

24US48KD.....	51	4338.....	12	6015.....	35	96704.....	23	99456.....	22	NS834.....	4
24US60KD.....	51	4339.....	11	6016.....	35	96705.....	23	99457.....	22	NS834A.....	4
24US72KD.....	51	4340.....	11	6017.....	35	96706.....	23	99521.....	60	NS885.....	43
24US84KD.....	51	45106.....	1	6018.....	35	96707.....	23	99551.....	50	NS893.....	4
24US96KD.....	51	45256.....	1	6019.....	35	96708.....	23	99653.....	52	NS926.....	27
2501.....	45	4635.....	12	60328.....	65	96709.....	23	99654.....	52	NS933.....	47
2502.....	45	4637.....	12	60329.....	65	96710.....	23	99738.....	21	NS943.....	44
2503.....	45	4640.....	11	60330.....	65	96711.....	23	99821.....	52	NS947KD.....	18
2505.....	45	4642.....	11	60P.....	43	96856.....	65	99822.....	52	NS968.....	27
2511.....	45	48P.....	43	6259.....	34	97055.....	30	99823.....	52	P2448.....	19
2512.....	45	50112.....	30	6262.....	59	97073.....	9	99824.....	52	P2460.....	19
2513.....	45	50313.....	43	6263.....	59	97102.....	44	99825.....	52	PC432.....	43
2515.....	45	50314.....	43	6265.....	59	97126.....	57	99826.....	52	PM2448.....	19
2521.....	45	50315.....	43	6266.....	59	97142.....	28	99866.....	7	PM2460.....	19
2522.....	45	50316.....	43	6300.....	2	97177.....	24	99936.....	29	PT2436P6.....	66
2523.....	45	50723.....	47	6301.....	2	97178.....	24	99970.....	22	PT2436S6.....	66
2525.....	45	50875.....	22	6303.....	2	97179.....	24	BDT18566.....	66	PT2448P6.....	66
2531.....	45	51019.....	47	6330.....	2	97180.....	24	BDT18568.....	66	PT2448S6.....	66
2532.....	45	51020.....	47	6331.....	2	97205.....	59	C1836HD.....	42	PT3048P6.....	66
2533.....	45	51021.....	47	6333.....	2	97243.....	15	C1836TB.....	42	PT3048S6.....	66
2535.....	45	51022.....	47	6345.....	63	97253.....	59	C1848HD.....	42	PT3060P6.....	66
2541.....	45	51023.....	47	6347.....	63	97285.....	44	C1848TB.....	42	PT3060S6.....	66
2542.....	45	51024.....	47	6348.....	63	97286.....	44	C1860HD.....	42	PT3660P6.....	66
2543.....	45	51025.....	47	6354.....	64	97287.....	44	C1860TB.....	42	PT3660S6.....	66
2545.....	45	51026.....	47	68P.....	43	97294.....	34	C2436HD.....	42	PT3672P6.....	66
2551.....	45	51027.....	47	72P.....	43	97294CK.....	34	C2436TB.....	42	PT3672S6.....	66
2552.....	45	51087.....	68	7331.....	2	97379.....	7	C2448HD.....	42	RGY16825.....	61
2553.....	45	51101.....	35	76P.....	43	97621.....	50	C2448TB.....	42		
2555.....	45	51102.....	35	84P.....	43	97718.....	15	C2460HD.....	42		
2561.....	45	51103.....	35	999.....	52-53	97720.....	22	C2460TB.....	42		
2563.....	45	51107.....	7	92052.....	5	97721.....	22	C2472HD.....	42		
2565.....	45	51169.....	47	92093.....	44	97722.....	22	C2472TB.....	42		
2571.....	45	51170.....	47	92094.....	44	97729.....	9	C405.....	69-70		
2573.....	45	51171.....	47	92096.....	1	97743.....	6	C410.....	69-70		
2575.....	45	51172.....	47	93020KD.....	18	97744.....	6	C418.....	69-70		
2581.....	45	51173.....	47	93037.....	28	97745.....	6	C421.....	69-70		
2582.....	45	51174.....	47	93189.....	30	97746.....	15	C430.....	69-70		
2583.....	45	51181.....	47	94029.....	47	97747.....	15	C440.....	43, 69-70		
2585.....	45	51182.....	47	94030.....	47	97753.....	46	C447.....	69-70		
3030HD.....	39	51233.....	45	94031.....	47	97754.....	46	C450.....	69-70		
3036HD.....	39	51268.....	48	94136.....	44	97755.....	46	C453.....	69-70		
3048HD.....	39	51270.....	48	94249.....	44	97769.....	24	C455.....	69-70		
30P36KD.....	51	51271.....	48	94273.....	47	97846.....	50	C460.....	69-70		
30P48KD.....	51	51273.....	48	94274.....	47	97873.....	53	C461.....	69-70		
30P60KD.....	51	51274.....	48	94275.....	47	97874.....	53	C464.....	69-70		
30P72KD.....	51	51276.....	48	95048.....	4	97875.....	53	C480.....	69-70		
30P84KD.....	51	51280.....	47	95136.....	58	97876.....	53	C482.....	69-70		
30P96KD.....	51	51298.....	47	95141.....	14	97877.....	53	C483.....	69-70		
30PBS36KD.....	51	51299.....	47	95219.....	30	97878.....	53	C485.....	69-70		
30PBS48KD.....	51	51300.....	47	95241.....	65	97879.....	53	C490.....	69-70		
30PBS60KD.....	51	51305.....	48	95333.....	23	9787C.....	53	C495.....	69-70		
30PBS72KD.....	51	51328.....	48	95370.....	65	9789C.....	53	C500.....	69-70		
30PBS84KD.....	51	51412.....	48	95403.....	46	9790C.....	53	C510.....	69-70		
30PBS96KD.....	51	51619.....	60	95404.....	46	97880.....	53	C511.....	69-70		
30SS36KD.....	51	51620.....	60	95405.....	46	97942.....	25	C513.....	69-70		
30SS48KD.....	51	51621.....	60	95410.....	47	98000.....	21	C514.....	69-70		
30SS60KD.....	51	51622.....	60	95413.....	23	98001.....	21	C517.....	69-70		
30SS72KD.....	51	51753.....	48	95433.....	3	98037.....	48	C518.....	69-70		
30SS84KD.....	51	51949.....	29	95435.....	48	98040.....	32	C526.....	69-70		
30SS96KD.....	51	51956.....	48	95436.....	48	98063.....	16	C527.....	69-70		
30SSB36KD.....	51	52038.....	4	95437.....	48	98138.....	22	C538.....	69-70		
30SSB48KD.....	51	52049.....	48	95549.....	48	98142.....	32	C539.....	69-70		
30SSB60KD.....	51	52050.....	48	95456.....	35	98144.....	53	C548.....	69-70		
30SSB72KD.....	51	52064.....	48	95631.....	46	98167.....	50	C557.....	69-70		
30SSB84KD.....	51	52199.....	6	95632.....	46	98179.....	21	C557B.....	69-70		
30SSB96KD.....	51	52264.....	48	95633.....	46	98181.....	25	C558.....	69-70		
30US36KD.....	51	52284.....	48	95634.....	44	98182.....	25	C559.....	69-70		
30US48KD.....	51	52352.....	48	95636.....	29	98183.....	25	C560.....	69-70		
30US60KD.....	51	52354.....	48	95661.....	56	98195.....	30	C566.....	69-70		
30US72KD.....	51	52355.....	48	95667.....	20	98213.....	32	NS345.....	28		
30US84KD.....	51	52437.....	48	95681.....	4	98272.....	32	NS475.....	47		
30US96KD.....	51	52446.....	48	95762.....	67	98301.....	32	NS496.....	43		
31842TT7.....	47	52677.....	68	95762RS.....	67	98716.....	29	NS557.....	56		
34P.....	43	52711.....	18	95864.....	3	98736.....	29	NS557A.....	56		
4004.....	36	52861.....	26	95883.....	44	98737.....	29	NS590A.....	22		
4005.....	36	52918.....	26	95958.....	1	98951.....	47	NS596A.....	22		
4006.....	36	52919.....	26	96004.....	17	98953.....	47	NS599A.....	22		
4008.....	36	52924.....	28	96005.....	17	98998.....	30	NS600A.....	22		
4009.....	36	53082.....	28	96055.....	67	99217.....	21	NS603A.....	22		
4010.....	36	53338.....	26	96055RS.....	67	99251.....	61	NS621KD.....	18		
4027.....	36	53757.....	26	96058.....	4,8	99271.....	60	NS648.....	5		
4065.....	36	54P.....	43	96087.....	23	99272.....	60	NS675.....	44		
42068.....	9	6004.....	35	96090.....	23	99273.....	60	NS675A.....	44		
42078.....	15	6005.....	35	96134BH.....	56	99274.....	60	NS745.....	32		
4330.....	10	6006.....	35	96328.....	14	99304.....	32,59	NS753.....	44		
4331.....	10	6008.....	35	96492.....	48	99309.....	22	NS765.....	55		
4332.....	10	6009.....	35	96617.....	46	99310.....	22	NS793.....	44		
4333.....	10	6010.....	35	96618.....	46	99360.....	68	NS832.....	4		
4337.....	12	6014.....	35	96619.....	46	99381.....	34	NS833.....	4		

**Options:**

B.....	2,71
B.....	66
C.....	54
CL (A).....	2,71
CL (B).....	2,71
CL (C).....	71
CL (D).....	71
CL (E).....	71
CW.....	21
DL.....	14-15
E.....	2,71
HD6.....	35
KU.....	10-11
MS.....	37-38
M6.....	37-38
M6.....	2,71
MD.....	2,71
PB.....	2,71
PP "A".....	2,71
PP "B".....	14,71
PP "C".....	71
PS.....	2,71
R.....	65
RD.....	14
SW.....	35
US.....	53
VB.....	2,71
XH.....	49
DSD.....	49
SSD.....	49
8.....	65
1359.....	2,71
36".....	54
48".....	54
60".....	54
72".....	54

# Get Featured!



## Send Us Your Photos, Reels, Posts & Videos!

Join our social community and stay updated with our latest promos, tips and more.

<https://www.NewAgeIndustrial.com/FeatureMyPhoto>

Facebook



YouTube



LinkedIn



Instagram

